

## M2i.20xx - 8 bit transient recorder up to 200 MS/s

- Up to 200 MS/s on 2 channels, 100 MS/s on 4 channels
- Simultaneously sampling on all channels
- Separate ADC and amplifier per channel
- 7 input ranges:  $\pm 50$  mV up to  $\pm 5$  V
- Up to 2 GSample on-board memory
- 512 MSample standard memory installed
- Window, pulse width, re-arm, OR/AND trigger
- Programmable input offset of  $\pm 400\%$
- Synchronization of up to 16 cards per system and up to 271 cards with system sync
- ABA mode: combination of data logger and fast digitizer on trigger
- Versatile software support for Windows and Linux



- 66 MHz 32 bit PCI-X interface
- 5V / 3.3V PCI compatible
- 100% compatible to conventional PCI > V2.1
- Sustained streaming mode up to 245 MB/s

- 2,5 GBit x1 PCIe Interface
- Works with x1/x4/x8/x16\* PCIe slots
- Software compatible to PCI
- Sustained streaming mode up to 160 MB/s

<b>Operating Systems</b>	<b>Recommended Software</b>	<b>Drivers and Examples</b>
<ul style="list-style-type: none"> <li>• Windows XP, Vista, 7, 8, 10</li> <li>• Linux Kernel 2.4, 2.6, 3.x, 4.x</li> <li>• Windows/Linux 32 and 64 bit</li> </ul>	<ul style="list-style-type: none"> <li>• SBench 6</li> <li>• MATLAB</li> <li>• LabVIEW, LabWindows/CVI</li> </ul>	<ul style="list-style-type: none"> <li>• Visual Basic, C/C++, GNU C++</li> <li>• Borland Delphi, .VB.NET, C#, J#</li> <li>• Python, Java, IVI</li> </ul>

Model	1 channel	2 channels	4 channels
M2i.2020	50 MS/s	50 MS/s	
M2i.2021	50 MS/s	50 MS/s	50 MS/s
M2i.2030	200 MS/s	100 MS/s	
M2i.2031	200 MS/s	200 MS/s	100 MS/s

### General Information

The cards of the M2i.20xx series are designed for the fast and high quality data acquisition. Each of the up to four input channels has its own A/D converter and its own programmable input amplifier. This allows to record signals on all channels with 8 bit resolution without any phase delay between them. The inputs can be selected to one of seven input ranges by software and can be programmed to compensate for an input offset of  $\pm 400\%$  of the input range. The extremely large on-board memory allows long time recording even with highest sampling rates. All four cards of the M2i.20xx series may use the whole installed on-board memory completely for the currently activated number of channels. A FIFO mode is also integrated on the board. This allows the acquisition of data continuously for online processing in the PC or for data storage on hard disk.

\*Some x16 PCIe slots are for the use of graphic cards only and can not be used for other cards.

## Software Support

### Windows drivers

The cards are delivered with drivers for Windows XP and Vista (32 bit), as well as Windows 7, Windows 8 and Windows 10 (32 bit and 64 bit). Programming examples for Visual C++, Borland C++ Builder, LabWindows/CVI, Borland Delphi, Visual Basic, VB.NET, C#, J#, Python, Java and IVI are included.

### Linux Drivers



All cards are delivered with full Linux support. Pre-compiled kernel modules are included for the most common distributions like RedHat, Fedora, Suse, Ubuntu LTS or Debian. The Linux support includes SMP systems, 32 bit and 64 bit systems, versatile programming examples for Gnu C++, Python as well as the possibility to get the driver sources for your own compilation.

### SBench 6

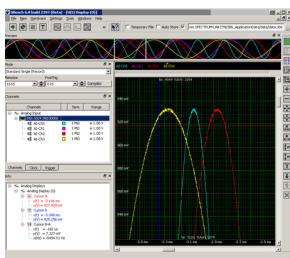

A base license of SBench 6, the easy-to-use graphical operating software for Spectrum cards, is included in the delivery. The base license makes it possible to test the card, display acquired data and make some basic measurements. It's a valuable tool for checking the card's performance and assisting with the unit's initial setup. The cards also come with a demo license for the SBench 6 professional version. This license gives the user the opportunity to test the additional features of the professional version with their hardware. The professional version contains several advanced measurement functions, such as FFTs and X/Y display, import and export utilities as well as support for all acquisition modes including data streaming. Data streaming allows the cards to continuously acquire data and transfer it directly to the PC RAM or hard disk. SBench 6 has been optimized to handle data files of several GBytes. SBench 6 runs under Windows as well as Linux (KDE, GNOME and Unity) operating systems. A test version of SBench 6 can be downloaded directly over the internet and can run the professional version in a simulation mode without any hardware installed. Existing customers can also request a demo license for the professional version from Spectrum. More details on SBench 6 can be found in the SBench 6 data sheet.

### Third-party products

Spectrum supports the most popular third-party software products such as LabVIEW, MATLAB or LabWindows/CVI. All drivers come with detailed documentation and working examples are included in the delivery. Support for other software packages, like VEE or DasyLab, can also be provided on request.

## Hardware features and options

### PCI/PCI-X



The cards with PCI/PCI-X bus connector use 32 Bit and up to 66 MHz clock rate for data transfer. They are 100% compatible to Conventional PCI > V2.1. The universal interface allows the use in PCI slots with 5 V I/O and 3.3 V I/O voltages as well as in PCI-

X or PCI 64 slots. The maximum sustained data transfer rate is 245 MByte/s per bus segment.

### PCI Express



The cards with PCI Express use a x1 PCIe connector. They can be used in PCI Express x1/x4/x8/x16 slots, except special graphic card slots, and are 100% software compatible to Conventional PCI > V2.1. The maximum sustained data transfer rate is

160 MByte/s per slot.

### Input Amplifier

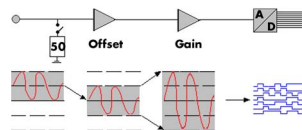

The analog inputs can be adapted to real world signals using a wide variety of settings that are individual for each channel. By using software commands the input termination can be changed

between 50 Ohm and 1 MOhm, one can select a matching input range and the signal offset can be compensated for.

### Ring buffer mode

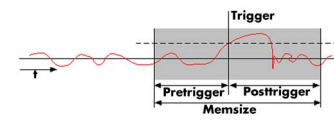

The ring buffer mode is the standard mode of all oscilloscope instruments. Digitized data is continuously written into a ring memory until a

trigger event is detected. After the trigger, post-trigger samples are recorded and pre-trigger samples can also be stored. The number of pre-trigger samples available simply equals the total ring memory size minus the number of post trigger samples.

### FIFO mode

The FIFO mode is designed for continuous data transfer between measurement board and PC memory (up to 245 MB/s on a PCI-X slot, up to 125 MB/s on a PCI slot and up to 160 MB/s on a PCIe slot) or hard disk. The control of the data stream is done automatically by the driver on interrupt request. The complete installed on-board memory is used for buffer data, making the continuous streaming extremely reliable.

### Channel trigger

The data acquisition instruments offer a wide variety of trigger modes. Besides the standard signal checking for level and edge as known from oscilloscopes it's also possible to define a window trigger. All trigger modes can be combined with the pulsewidth trigger. This makes it possible to trigger on signal errors like too long or too short pulses. In addition to this a re-arming mode (for accurate trigger recognition on noisy signals) the AND/OR conjunction of different trigger events is possible. As a unique feature it is possible to use deactivated channels as trigger sources.

### External trigger I/O

All instruments can be triggered using an external TTL signal. It's possible to use positive or negative edge also in combination with a programmable pulse width. An internally recognised trigger event can - when activated by software - be routed to the trigger connector to start external instruments.

### Pulse width

Defines the minimum or maximum width that a trigger pulse must have to generate a trigger event. Pulse width can be combined with channel trigger, pattern trigger and external trigger.

## Multiple Recording

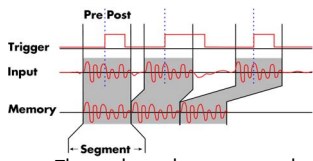

The Multiple Recording mode allows the recording of several trigger events with an extremely short re-arming time. The hardware doesn't need to be restarted in between. The on-board memory is divided in several segments of the same size. Each of them is filled with data if a trigger event occurs. Pre- and posttrigger of the segments can be programmed. The number of acquired segments is only limited by the used memory and is unlimited when using FIFO mode.

## Gated Sampling

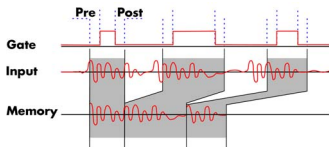

The Gated Sampling mode allows data recording controlled by an external gate signal. Data is only recorded if the gate signal has a programmed level. In addition a pre-area before start of the gate signal as well as a post area after end of the gate signal can be acquired. The number of gate segments is only limited by the used memory and is unlimited when using FIFO mode.

## Timestamp

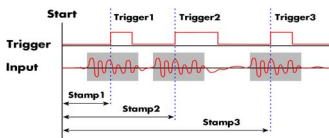

The timestamp function writes the time positions of the trigger events in an extra memory. The timestamps are relative to the start of recording, a defined zero time, externally synchronized to a radio clock, an IRIG-B or a GPS receiver. Using the external synchronization gives a precise time relation for acquisitions of systems on different locations.

## ABA mode

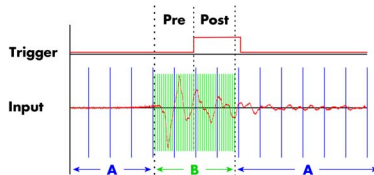

The ABA mode combines slow continuous data recording with fast acquisition on trigger events. The ABA mode works like a slow data logger combined with a fast digitizer. The exact position of the trigger events is stored as timestamps in an extra memory.

## External clock I/O

Using a dedicated connector a sampling clock can be fed in from an external system. It's also possible to output the internally used sampling clock to synchronise external equipment to this clock.

## Reference clock

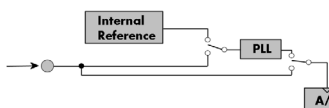

The option to use a precise external reference clock (typically 10 MHz) is necessary to synchronize the instrument for high-quality measurements with external equipment (like a signal source). It's also possible to enhance the stability of the sampling clock in this way. The driver automatically generates the requested sampling clock from the fed in reference clock.

## Star-Hub

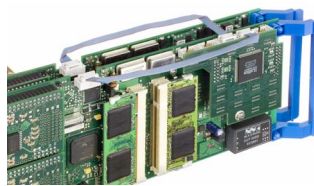

The star-hub is an additional module allowing the phase stable synchronisation of up to 16 boards in one system. Independent of the number of boards there is no phase delay between all channels. The star-hub distributes trigger and clock information between all boards. As a result all connected boards are running with the same clock and the same trigger. All trigger sources can be combined with OR/AND allowing all channels of all cards to be trigger source at the same time. The star-hub is available as 5 card and 16 card version. The 5 card version doesn't need an extra slot.

## 271 synchronous cards with the System Star-Hub

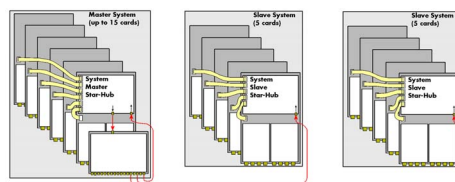

With the help of multiple system star-hubs it is possible to link up to 17 system phase synchronous with each other. Each system can then contain up to 16 cards (master only 15). In total 271 cards can be used fully synchronously in a bunch of systems. One master system distributes clock and trigger signal to all connected slave systems.

## BaseXIO (Asynchronous I/O, enhanced trigger)

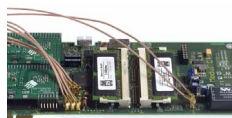

The BaseXIO option offers 8 asynchronous digital I/O lines on the base card. The direction can be selected by software in groups of four. This allows e.g. external equipment control or status monitoring. Two of these lines can also be used as additional external trigger sources. This allows the building of complex trigger conjunctions with external gated triggers as well as AND/OR conjunction of multiple external trigger sources like, for example, the picture and row synchronisation of video signals. In addition one of the I/O lines can be used as reference clock for the Timestamp counter.

## External Amplifiers



For the acquisition of extremely small voltage levels with a high bandwidth a series of external amplifiers is available. Each of the one channel amplifiers is working with a fixed input impedance and allows - depending on the bandwidth - to select different amplification levels between  $\times 10$  (20 dB) up to  $\times 1000$  (60 dB). Using the external amplifiers of the SPA series voltage levels in the  $\mu\text{V}$  and  $\text{mV}$  area can be acquired.

## Technical Data

### Analog Inputs

Resolution		8 bit
Input Range	software programmable	$\pm 50$ mV, $\pm 100$ mV, $\pm 200$ mV, $\pm 500$ mV, $\pm 1$ V, $\pm 2$ V, $\pm 5$ V
Input Mode	fixed	bipolar, single-ended
Input Offset	software programmable	$\pm 400\%$ of input range in steps of 1%
ADC Differential non linearity (DNL)	ADC only	$\pm 0.5$ LSB
ADC Integral non linearity (INL)	ADC only	$\pm 0.5$ LSB
Offset error (full speed)	after warm-up and calibration	$\leq 0.1\%$ of range
Gain error (full speed)	after warm-up and calibration	$\leq 2\%$
Crosstalk: 1 MHz Signal, 50 $\Omega$ termination	all input ranges	$\leq -62$ dB on adjacent channels
Analog input impedance	software programmable	50 $\Omega$ or 1 M $\Omega$    25 pF
Analog input coupling	fixed	DC
Over voltage protection (active card)	ranges $\leq \pm 500$ mV	$\pm 5$ V
Over voltage protection (active card)	ranges $> \pm 500$ mV	$\pm 50$ V
Input signal with 50 $\Omega$ termination		max 5 V rms
Channel selection	software programmable	1, 2 or 4 (maximum is model dependent)

### Trigger

Available trigger modes	software programmable	Channel Trigger, External, Software, Window, Pulse, Re-Arm, Or/And, Delay
Trigger level resolution	software programmable	8 bit
Trigger edge	software programmable	Rising edge, falling edge or both edges
Trigger pulse width	software programmable	0 to [64k - 1] samples in steps of 1 sample
Trigger delay	software programmable	0 to [64k - 1] samples in steps of 1 sample
Multi, Gate: re-arming time		$< 4$ samples (+ programmed pretrigger)
Pretrigger at Multi, ABA, Gate, FIFO	software programmable	8 up to [16352 Samples / number of active channels] in steps of 8
Posttrigger	software programmable	4 up to [8G - 4] samples in steps of 4 (defining pretrigger in standard scope mode)
Memory depth	software programmable	8 up to [installed memory / number of active channels] samples in steps of 4
Multiple Recording/ABA segment size	software programmable	8 up to [installed memory / 2 / active channels] samples in steps of 4
Trigger output delay		One positive edge after internal trigger event
Internal/External trigger accuracy	$\leq 100$ MS/s	1 sample
Internal/External trigger accuracy	$> 100$ MS/s	2 samples
External trigger type (input and output)		3.3V LVTTTL compatible (5V tolerant)
External trigger input		Low $\leq 0.8$ V, High $\geq 2.0$ V, $\geq 8$ ns in pulse stretch mode, $\geq 2$ clock periods all other modes
External trigger maximum voltage		-0.5 V up to +5.7 V (internally clamped to 5.0V, 100 mA max. clamping current)
Trigger impedance	software programmable	50 Ohm / high impedance ( $> 4k\Omega$ )
External trigger output type		3.3 V LVTTTL
External trigger output levels		Low $\leq 0.4$ V, High $\geq 2.4$ V, TTL compatible
External trigger output drive strength		Capable of driving 50 ohm load, maximum drive strength $\pm 128$ mA

### Clock

Clock Modes	software programmable	internal PLL, internal quartz, external clock, external divided, external reference clock, sync
Internal clock range (PLL mode)	software programmable	1 kS/s to max using internal reference, 50kS/s to max using external reference clock
Internal clock accuracy		$\leq 20$ ppm
Internal clock setup granularity		$\leq 1\%$ of range (100M, 10M, 1M, 100k,...): Examples: range 1M to 10M: stepsize $\leq 100k$
External reference clock range	software programmable	$\geq 1.0$ MHz and $\leq 125.0$ MHz
External clock impedance	software programmable	50 Ohm / high impedance ( $> 4k\Omega$ )
External clock range		see „Dynamic Parameters“ table below
External clock delay to internal clock		5.4 ns
External clock type/edge		3.3V LVTTTL compatible, rising edge used
External clock input		Low level $\leq 0.8$ V, High level $\geq 2.0$ V, duty cycle: 45% - 55%
External clock maximum voltage		-0.5 V up to +3.8 V (internally clamped to 3.3V, 100 mA max. clamping current)
External clock output type		3.3 V LVTTTL
External clock output levels		Low $\leq 0.4$ V, High $\geq 2.4$ V, TTL compatible
External clock output drive strength		Capable of driving 50 ohm load, maximum drive strength $\pm 128$ mA
Synchronization clock divider	software programmable	2 up to [8k - 2] in steps of 2
ABA mode clock divider for slow clock	software programmable	8 up to 524280 in steps of 8

### BaseXIO Option

BaseXIO modes	software programmable	Asynch digital I/O, 2 additional trigger, timestamp reference clock, timestamp digital inputs
BaseXIO direction	software programmable	Each 4 lines can be programmed in direction
BaseXIO input		TTL compatible: Low $\leq 0.8$ V, High $\geq 2.0$ V
BaseXIO input impedance		4.7 kOhm towards 3.3 V
BaseXIO input maximum voltage		-0.5 V up to +5.5 V
BaseXIO output type		3.3 V LVTTTL
BaseXIO output levels		TTL compatible: Low $\leq 0.4$ V, High $\geq 2.4$ V
BaseXIO output drive strength		32 mA maximum current, no 50 $\Omega$ loads

## Connectors

Analog Inputs		3 mm SMB male (one for each single-ended input)	Cable-Type: Cab-3f-xx-xx
Trigger Input/Output	programmable direction	3 mm SMB male (one connector)	Cable-Type: Cab-3f-xx-xx
Clock Input/Output	programmable direction	3 mm SMB male (one connector)	Cable-Type: Cab-3f-xx-xx
Option Digital Inputs/Outputs		40 pole half pitch (Hirose FX2 series)	Cable-Type: Cab-d40-xx-xx
Option BaseXIO		8 x 3 mm SMB male on extra bracket, internally 8 x MMCX female	

## Environmental and Physical Details

Dimension (PCB only)	312 mm x 107 mm (full PCI length)
Width (Standard or with option star-hub 5)	1 full size slot
Width (star-hub 16)	additionally back of adjacent neighbour slots
Width (with option BaseXIO)	additionally extra bracket on neighbour slot
Width (with option -digin, -digin or -60xx-AmpMod)	additionally half length of adjacent neighbour slot
Weight (depending on version)	290g (smallest version) up to 460g (biggest version with all options, including star-hub)
Warm up time	10 minutes
Operating temperature	0°C to 50°C
Storage temperature	-10°C to 70°C
Humidity	10% to 90%

## PCI/PCI-X specific details

PCI / PCI-X bus slot type	32 bit 33 MHz or 32 bit 66 MHz
PCI / PCI-X bus slot compatibility	32/64 bit, 33-133 MHz, 3,3 V and 5 V I/O
Sustained streaming mode	> 245 MB/s (in a PCI-X slot clocked at 66 MHz or higher)

## PCI Express specific details

PCIe slot type	x1 Generation 1
PCIe slot compatibility	x1/x4/x8/x16 (Some x16 PCIe slots are for graphic cards only and can not be used)
Sustained streaming mode	> 160 MB/s

## Certification, Compliance, Warranty

EMC Immunity	Compliant with CE Mark
EMC Emission	Compliant with CE Mark
Product warranty	5 years starting with the day of delivery
Software and firmware updates	Life-time, free of charge

## Power Consumption

	PCI / PCI-X			PCI EXPRESS		
	3.3 V	5 V	Total	3.3V	12V	Total
M2i.20x0 (512 MSample memory)	2.2 A	0.5 A	9.8 W	0.4 A	1.0 A	13.3 W
M2i.20x1 (512 MSample memory)	2.8 A	0.8 A	13.2 W	0.4 A	1.2 A	15.7 W
M2i.2031 (4 GSample memory) max power	3.9 A	0.8 A	16.9 W	0.4 A	2.0 A	25.3 W

## MTBF

MTBF	500000 hours
------	--------------

## Dynamic Parameters

	M2i.2020		M2i.2021		M2i.2030 DN2.203-02		M2i.2031 DN2.203-04 DN2.203-08	
	50 MS/s	100 MS/s	50 MS/s	100 MS/s	100 MS/s	100 MS/s	100 MS/s	100 MS/s
min internal clock	1kS/s		1kS/s		1kS/s		1kS/s	
max internal clock	50 MS/s		50 MS/s		200 MS/s		200 MS/s	
min external clock	1 MS/s		1 MS/s		1 MS/s		1 MS/s	
max external clock	50 MS/s		50 MS/s		100 MS/s		100 MS/s	
-3 dB bandwidth ±50 mV	DC to 25 MHz		DC to 25 MHz		DC to 60 MHz		DC to 60 MHz	
-3 dB bandwidth ±100 mV	DC to 25 MHz		DC to 25 MHz		DC to 80 MHz		DC to 80 MHz	
-3 dB bandwidth ≥ ±200 mV	DC to 25 MHz		DC to 25 MHz		DC to 90 MHz		DC to 90 MHz	
Zero noise level (≤ ±100 mV)	≤ 0,6 LSB		≤ 0,9 LSB		≤ 1,5 LSB		≤ 2.0 LSB	
Zero noise level (> ±100 mV)	≤ 0,6 LSB		≤ 0,7 LSB		≤ 1,3 LSB		≤ 1,5 LSB	
Test - sampling rate	50 MS/s		50 MS/s		100 MS/s		100 MS/s	
Test signal frequency	1 MHz	4 MHz	1 MHz	4 MHz	1 MHz	9 MHz	1 MHz	9 MHz
SNR (typ)	47.5 dB	47.5 dB	46.8 dB	46.5 dB	45.3 dB	45.0 dB	45.0 dB	44.5 dB
THD (typ)	-56.0 dB	-55.5 dB	-56.0 dB	-55.5 dB	-51.5 dB	-49.5 dB	-49.5 dB	-49.5 dB
SFDR (typ), excl. harm.	61.3 dB	61.0 dB	60.3 dB	60.1 dB	59.0 dB	57.0 dB	59.0 dB	57.0 dB
ENOB (based on SNR)	7.6 bit	7.6 bit	7.5 bit	7.4 bit	7.2 bit	7.2 bit	7.2 bit	7.2 bit
ENOB (based on SINAD)	7.5 bit	7.5 bit	7.4 bit	7.3 bit	7.1 bit	7.0 bit	7.1 bit	7.0 bit

Dynamic parameters are measured at ± 1 V input range (if no other range is stated) and 50 Ohm termination with the samplerate specified in the table. Measured parameters are averaged 20 times to get typical values. Test signal is a pure sine wave of the specified frequency with > 99% amplitude. SNR and RMS noise parameters may differ depending on the quality of the used PC. SNR = Signal to Noise Ratio, THD = Total Harmonic Distortion, SFDR = Spurious Free Dynamic Range, SINAD = Signal Noise and Distortion, ENOB = Effective Number of Bits. For a detailed description please see application note 002.

# Hardware block diagram

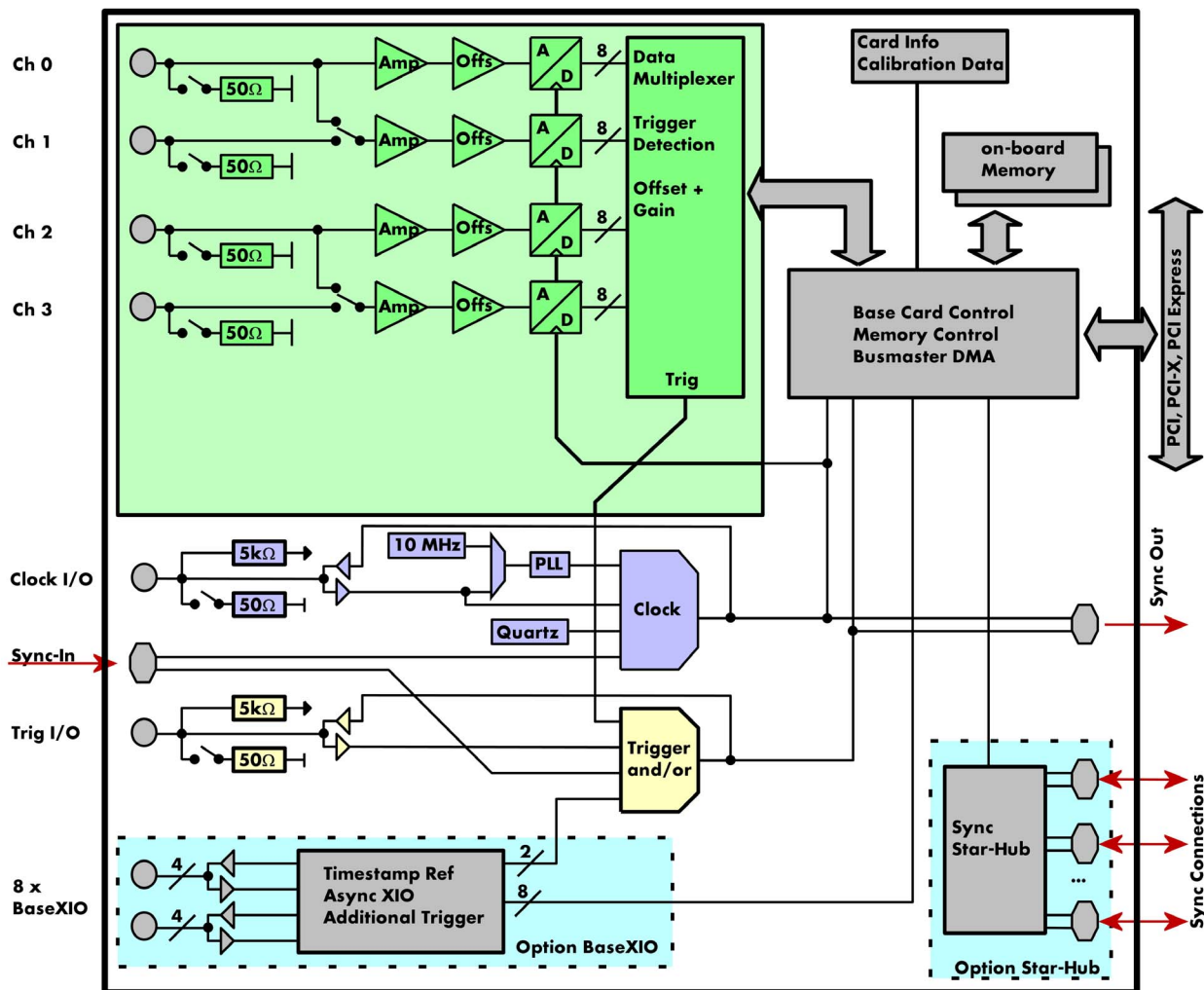

## Order Informations

The card is delivered with 512 MSample on-board memory and supports standard acquisition (Scope), FIFO acquisition (streaming), Multiple Recording, Gated Sampling, ABA mode and Timestamps. Operating system drivers for Windows/Linux 32 bit and 64 bit, examples for C/C++, LabVIEW (Windows), MATLAB (Windows and Linux), LabWindows/CVI, IVI, .NET, Delphi, Visual Basic, Java, Python and a Base license of the oscilloscope software SBench 6 are included. Drivers for other 3rd party products like VEE or DASyLab may be available on request.

**Adapter cables are not included. Please order separately!**

### PCI Express (PCIe)

PCI Express	PCI/PCI-X	Standard mem	1 channel	2 channels	4 channels
M2i.2020-exp	M2i.2020	512 MByte	50 MS/s	50 MS/s	
M2i.2021-exp	M2i.2021	512 MByte	50 MS/s	50 MS/s	50 MS/s
M2i.2030-exp	M2i.2030	512 MByte	200 MS/s	100 MS/s	
M2i.2031-exp	M2i.2031	512 MByte	200 MS/s	200 MS/s	100 MS/s

### Memory

Order no.	Option
M2i.xxxx-1GB	Memory upgrade to 1 GB of total memory
M2i.xxxx-2GB	Memory upgrade to 2 GB of total memory

### Options

Order no.	Option
M2i.xxxx-SH5 (1)	Synchronization Star-Hub for up to 5 cards, only 1 slot width
M2i.xxxx-SH16 (1)	Synchronization Star-Hub for up to 16 cards
M2i.xxxx-SSHM (1)	System-Star-Hub Master for up to 15 cards in the system and up to 17 systems, PCI 32 Bit card, sync cables and extra bracket for clock and trigger distribution included
M2i.xxxx-SSHMe (1)	System-Star-Hub Master for up to 15 cards in the system and up to 17 systems, PCI Express card, sync cables and extra bracket for clock and trigger distribution included
M2i.xxxx-SSHS5 (1)	System-Star-Hub Slave for 5 cards in one system, one slot width all sync cables + bracket included
M2i.xxxx-SSHS16 (1)	System-Star-Hub Slave for 16 cards in system, two slots width, all sync cables + bracket included
M2i.xxxx-bxio	Option BaseXIO: 8 digital I/O lines usable as asynchronous I/O, timestamp ref-clock and additional external trigger lines, additional bracket with 8 SMB connectors
M2i-upgrade	Upgrade for M2i.xxxx: later installation of option -M2i.xxxx-2GB, -SH5, -SH16 or -bxio

### Services

Order no.	
Recal	Recalibration at Spectrum incl. calibration protocol

### Cables

for Connections	Length	Order no.				
		to BNC male	to BNC female	to SMA male	to SMA female	to SMB female
Analog/Clock/Trigger	80 cm	Cab-3f-9m-80	Cab-3f-9f-80	Cab-3f-3mA-80	Cab-3f-3fA-80	Cab-3f-3f-80
Analog/Clock/Trigger	200 cm	Cab-3f-9m-200	Cab-3f-9f-200	Cab-3f-3mA-200	Cab-3f-3fA-200	Cab-3f-3f-200
Probes (short)	5 cm		Cab-3f-9f-5			

### Amplifiers

Order no.	Bandwidth	Connection	Input Impedance	Coupling	Amplification
SPA.1412 <sup>(2)</sup>	200 MHz	BNC	1 MOhm	AC/DC	x10/x100 (20/40 dB)
SPA.1411 <sup>(2)</sup>	200 MHz	BNC	50 Ohm	AC/DC	x10/x100 (20/40 dB)
SPA.1232 <sup>(2)</sup>	10 MHz	BNC	1 MOhm	AC/DC	x100/x1000 (40/60 dB)
SPA.1231 <sup>(2)</sup>	10 MHz	BNC	50 Ohm	AC/DC	x100/x1000 (40/60 dB)
Information	External Amplifiers with one channel, BNC/SMA female connections on input and output, manually adjustable offset, manually switchable settings. An external power supply for 100 to 240 VAC is included. Please be sure to order an adapter cable matching the amplifier connector type and matching the connector type for your A/D card input.				

### Software SBench6

Order no.	
SBench6	Base version included in delivery. Supports standard mode for one card.
SBench6-Pro	Professional version for one card: FIFO mode, export/import, calculation functions
SBench6-Multi	Option multiple cards: Needs SBench6-Pro. Handles multiple synchronized cards in one system.
Volume Licenses	Please ask Spectrum for details.

### Software Options

Order no.	
SpcRServer	Remote Server Software Package - LAN remote access for M2i/M3i/M4i/M4x/M2p cards

<sup>(1)</sup> : Just one of the options can be installed on a card at a time.

<sup>(2)</sup> : Third party product with warranty differing from our export conditions. No volume rebate possible.

### Technical changes and printing errors possible

SBench, digitizerNETBOX and generatorNETBOX are registered trademarks of Spectrum Instrumentation GmbH. Microsoft, Visual C++, Visual Basic, Windows, Windows 98, Windows NT, Window 2000, Windows XP, Windows Vista, Windows 7, Windows 8 and Windows 10 are trademarks/registered trademarks of Microsoft Corporation. LabVIEW, DASyLab, Diadem and LabWindows/CVI are trademarks/registered trademarks of National Instruments Corporation. MATLAB is a trademark/registered trademark of The Mathworks, Inc. Keysight VEE, VEE Pro and VEE OneLab are trademarks/registered trademarks of Keysight Technologies, Inc. FlexPro is a registered trademark of Weisang GmbH & Co. KG. PCIe, PCI Express and PCI-X and PCI-SIG are trademarks of PCI-SIG. LXI is a registered trademark of the LXI Consortium. PICMG and CompactPCI are trademarks of the PCI Industrial Computation Manufacturers Group. Oracle and Java are registered trademarks of Oracle and/or its affiliates. Intel and Intel Xeon are trademarks or registered trademarks of Intel Corporation. AMD and Optron are trademarks or registered trademarks of Advanced Micro Devices.