

M2i.46xx - 8 channel 16 bit A/D up to 3 MS/s

- 2, 4 or 8 channels with 200 kS/s up to 3 MS/s
- Simultaneously sampling on all channels
- Software selectable single-ended or differential inputs
- Separate ADC and amplifier per channel
- complete on-board calibration
- 8 input ranges: ± 50 mV up to ± 10 V
- Up to 1 GSample on-board memory
- 256 MSample standard on-board memory
- Window, pulse width, re-arm, spike, OR/AND trigger
- Programmable input offset of ± 5 V
- Synchronization of up to 16 cards per system and up to 271 cards with system sync
- Different operation modes: ABA mode, Multiple Recording, Gated Sampling

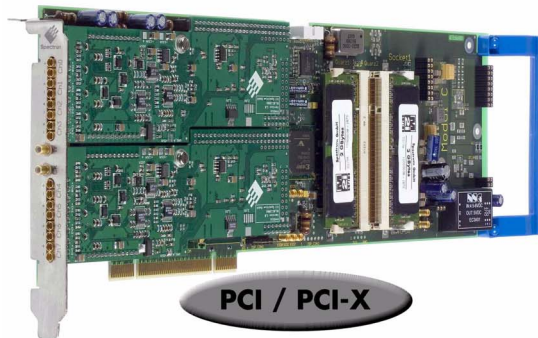

M2i
series

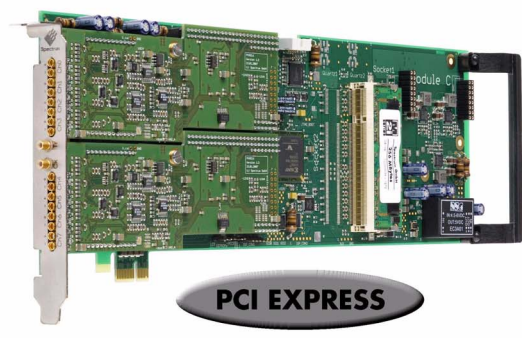

- 66 MHz 32 bit PCI-X interface
- 5V / 3.3V PCI compatible
- 100% compatible to conventional PCI > V2.1
- Sustained streaming mode up to 245 MB/s

- 2,5 GBit x1 PCIe Interface
- Works with x1/x4/x8/x16* PCIe slots
- Software compatible to PCI
- Sustained streaming mode up to 160 MB/s

Operating Systems

- Windows XP, Vista, 7, 8, 10
- Linux Kernel 2.4, 2.6, 3.x, 4.x
- Windows/Linux 32 and 64 bit

Recommended Software

- SBench 6
- MATLAB
- LabVIEW, LabWindows/CVI

Drivers and Examples

- Visual Basic, C/C++, GNU C++
- Borland Delphi, .VB.NET, C#, J#
- Python, Java, IVI

Model	1 channel	2 channels	4 channels	8 channels
M2i.4620	200 kS/s	200 kS/s		
M2i.4621	200 kS/s	200 kS/s	200 kS/s	
M2i.4622	200 kS/s	200 kS/s	200 kS/s	200 kS/s
M2i.4630	500 kS/s	500 kS/s		
M2i.4631	500 kS/s	500 kS/s	500 kS/s	
M2i.4632	500 kS/s	500 kS/s	500 kS/s	500 kS/s
M2i.4640	1 MS/s	1 MS/s		
M2i.4641	1 MS/s	1 MS/s	1 MS/s	
M2i.4642	1 MS/s	1 MS/s	1 MS/s	1 MS/s
M2i.4650	3 MS/s	3 MS/s		
M2i.4651	3 MS/s	3 MS/s	3 MS/s	
M2i.4652	3 MS/s	3 MS/s	3 MS/s	3 MS/s

General Information

The M2i.46xx series allows recording of one, two, four or eight channels with sampling rates of 200 kS/s up to 3 MS/s. These cards offer outstanding A/D features both in resolution and speed for PCI/PCI-X and PCI Express. They are available in several versions and different speed grades making it possible for the user to find an individual solution. All boards of the M2i.46xx series may use the whole installed on-board memory, of up to 1 GSamples, completely for the currently activated number of channels. The enhanced FIFO engine is capable of streaming even 8 channels with 3 MS/s sustained to memory or hard disk.

*Some x16 PCIe slots are for the use of graphic cards only and can not be used for other cards.

Software Support

Windows drivers

The cards are delivered with drivers for Windows XP and Vista (32 bit), as well as Windows 7, Windows 8 and Windows 10 (32 bit and 64 bit). Programming examples for Visual C++, Borland C++ Builder, LabWindows/CVI, Borland Delphi, Visual Basic, VB.NET, C#, J#, Python, Java and IVI are included.

Linux Drivers



All cards are delivered with full Linux support. Pre-compiled kernel modules are included for the most common distributions like RedHat, Fedora, Suse, Ubuntu LTS or Debian. The Linux support includes SMP systems, 32 bit and 64 bit systems, versatile programming examples for Gnu C++, Python as well as the possibility to get the driver sources for your own compilation.

SBench 6

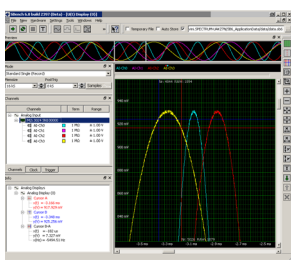

A base license of SBench 6, the easy-to-use graphical operating software for Spectrum cards, is included in the delivery. The base license makes it possible to test the card, display acquired data and make some basic measurements. It's a valuable tool for checking the card's performance and assisting with the unit's initial setup.

The cards also come with a demo license for the SBench 6 professional version. This license gives the user the opportunity to test the additional features of the professional version with their hardware. The professional version contains several advanced measurement functions, such as FFTs and X/Y display, import and export utilities as well as support for all acquisition modes including data streaming. Data streaming allows the cards to continuously acquire data and transfer it directly to the PC RAM or hard disk. SBench 6 has been optimized to handle data files of several GBytes. SBench 6 runs under Windows as well as Linux (KDE, GNOME and Unity) operating systems. A test version of SBench 6 can be downloaded directly over the internet and can run the professional version in a simulation mode without any hardware installed. Existing customers can also request a demo license for the professional version from Spectrum. More details on SBench 6 can be found in the SBench 6 data sheet.

Third-party products

Spectrum supports the most popular third-party software products such as LabVIEW, MATLAB or LabWindows/CVI. All drivers come with detailed documentation and working examples are included in the delivery. Support for other software packages, like VEE or DasyLab, can also be provided on request.

Hardware features and options

PCI/PCI-X



The cards with PCI/PCI-X bus connector use 32 Bit and up to 66 MHz clock rate for data transfer. They are 100% compatible to Conventional PCI > V2.1. The universal interface allows the use in PCI slots with 5 V I/O and 3.3 V I/O voltages as well as in PCI-

X or PCI 64 slots. The maximum sustained data transfer rate is 245 MByte/s per bus segment.

PCI Express



The cards with PCI Express use a x1 PCIe connector. They can be used in PCI Express x1/x4/x8/x16 slots, except special graphic card slots, and are 100% software compatible to Conventional PCI > V2.1. The maximum sustained data transfer rate is

160 MByte/s per slot.

Input Amplifier

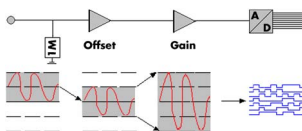

The analog inputs can be adapted to real world signals using a wide variety of settings that are individual for each channel. By using software commands one can select a matching input range

and the signal offset can be compensated.

Differential inputs

With a simple software command the inputs can individually be switched from single-ended (in relation to ground) to differential, without losing any inputs. When the inputs are used in differential mode the A/D converter measures the difference between two lines with relation to system ground.

Automatic on-board calibration

All of the channels are calibrated in factory before the board is shipped. To compensate for different variations like PC power supply, temperature and aging, the software driver provides routines for an automatic onboard offset and gain calibration of all input ranges. All the cards contain a high precision on-board calibration reference.

Ring buffer mode

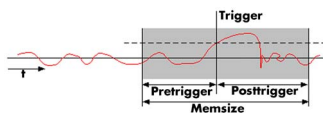

The ring buffer mode is the standard mode of all oscilloscope instruments. Digitized data is continuously written into a ring memory until a

trigger event is detected. After the trigger, post-trigger samples are recorded and pre-trigger samples can also be stored. The number of pre-trigger samples available simply equals the total ring memory size minus the number of post trigger samples.

FIFO mode

The FIFO mode is designed for continuous data transfer between measurement board and PC memory (up to 245 MB/s on a PCI-X slot, up to 125 MB/s on a PCI slot and up to 160 MB/s on a PCIe slot) or hard disk. The control of the data stream is done automatically by the driver on interrupt request. The complete installed on-board memory is used for buffer data, making the continuous streaming extremely reliable.

Channel trigger

The data acquisition instruments offer a wide variety of trigger modes. Besides the standard signal checking for level and edge as known from oscilloscopes it's also possible to define a window trigger. All trigger modes can be combined with the pulsewidth trigger. This makes it possible to trigger on signal errors like too long or too short pulses. In addition to this a re-arming mode (for accurate trigger recognition on noisy signals) the AND/OR conjunction of different trigger events is possible. As a unique feature it is possible to use deactivated channels as trigger sources.

External trigger I/O

All instruments can be triggered using an external TTL signal. It's possible to use positive or negative edge also in combination with

a programmable pulse width. An internally recognised trigger event can - when activated by software - be routed to the trigger connector to start external instruments.

Pulse width

Defines the minimum or maximum width that a trigger pulse must have to generate a trigger event. Pulse width can be combined with channel trigger, pattern trigger and external trigger.

Multiple Recording

The Multiple Recording mode allows the recording of several trigger events with an extremely short re-arming time. The hardware doesn't need to be restarted in between. The on-board memory is divided in several segments of the same size. Each of them is filled with data if a trigger event occurs. Pre- and posttrigger of the segments can be programmed. The number of acquired segments is only limited by the used memory and is unlimited when using FIFO mode.

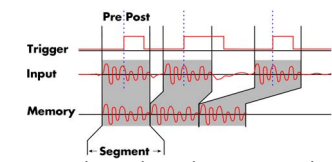

Gated Sampling

The Gated Sampling mode allows data recording controlled by an external gate signal. Data is only recorded if the gate signal has a programmed level. In addition a pre-area before start of the gate signal as well as a post area after end of the gate signal can be acquired. The number of gate segments is only limited by the used memory and is unlimited when using FIFO mode.

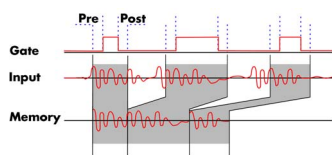

Timestamp

The timestamp function writes the time positions of the trigger events in an extra memory. The timestamps are relative to the start of recording, a defined zero time, externally synchronized to a radio clock, an IRIG-B or a GPS receiver. Using the external synchronization gives a precise time relation for acquisitions of systems on different locations.

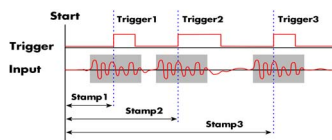

External clock I/O

Using a dedicated connector a sampling clock can be fed in from an external system. It's also possible to output the internally used sampling clock to synchronise external equipment to this clock.

ABA mode

The ABA mode combines slow continuous data recording with fast acquisition on trigger events. The ABA mode works like a slow data logger combined with a fast digitizer. The exact position of the trigger events is stored as timestamps in an extra memory.

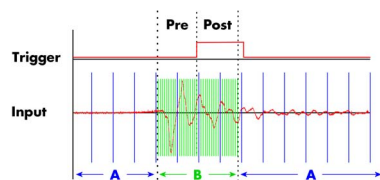

Reference clock

The option to use a precise external reference clock (typically 10 MHz) is necessary to synchronize the instrument for high-quality measurements with external equipment (like a signal source). It's

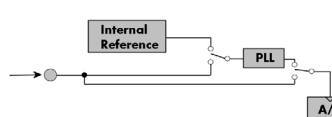

also possible to enhance the stability of the sampling clock in this way. The driver automatically generates the requested sampling clock from the fed in reference clock.

Star-Hub

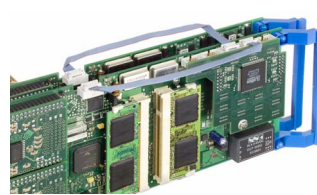

The star-hub is an additional module allowing the phase stable synchronisation of up to 16 boards in one system. Independent of the number of boards there is no phase delay between all channels. The star-hub distributes trigger and clock information between all boards. As a result all connected boards are running with the same clock and the same trigger. All trigger sources can be combined with OR/AND allowing all channels of all cards to be trigger source at the same time. The star-hub is available as 5 card and 16 card version. The 5 card version doesn't need an extra slot.

271 synchronous cards with the System Star-Hub

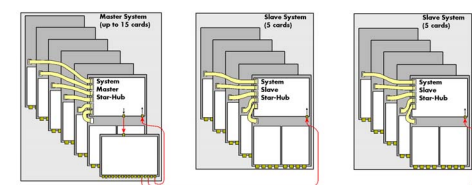

With the help of multiple system star-hubs it is possible to link up to 17 system phase synchronous with each other.

Each system can then contain up to 16 cards (master only 15). In total 271 cards can be used fully synchronously in a bunch of systems. One master system distributes clock and trigger signal to all connected slave systems.

BaseXIO (Asynchronous I/O, enhanced trigger)



The BaseXIO option offers 8 asynchronous digital I/O lines on the base card. The direction can be selected by software in groups of four. This allows e.g. external equipment control or status monitoring. Two of these lines can also be used as additional external trigger sources. This allows the building of complex trigger conjunctions with external gated triggers as well as AND/OR conjunction of multiple external trigger sources like, for example, the picture and row synchronisation of video signals. In addition one of the I/O lines can be used as reference clock for the Timestamp counter.

Technical Data

Analog Inputs

Resolution		16 bit (± 32000 values)
Input Range	software programmable	± 50 mV, ± 100 mV, ± 250 mV, ± 500 mV, ± 1 V, ± 2 V, ± 5 V, ± 10 V
Input Type	software programmable	Single-ended or True Differential (individually programmable per channel)
Input Offset (single-ended)	software programmable	programmable to ± 5 V in steps of 1 mV, not exceeding ± 10 V input
ADC Differential non linearity (DNL)	ADC only	465x: ± 2 LSB, all others ± 1 LSB
ADC Integral non linearity (INL)	ADC only	465x: ± 2 LSB, all others ± 1 LSB
Offset error (full speed)	after warm-up and calibration	$\leq 0.1\%$ of range ± 0.2 mV
Gain error (full speed)	after warm-up and calibration	$\leq 0.1\%$
Crosstalk: 100 kHz Signal, 50 ohm termination	all input ranges	≤ -110 dB on adjacent channels
Analog Input impedance	fixed	1 MOhm 25 pF
Analog input coupling	fixed	DC
Over voltage protection (active card)	all ranges	± 30 V
CMRR (Common Mode Rejection Ratio)	range $\leq \pm 500$ mV	> 70 dB
CMRR (Common Mode Rejection Ratio)	range $\geq \pm 1$ V	> 46 dB
Channel selection (single-ended inputs)	software programmable	1, 2, 4, 8 or 16 channels (maximum is model dependent)
Channel selection (true differential inputs)	software programmable	1, 2, 4, 8 or 16 channels (maximum is model dependent)

Trigger

Available trigger modes	software programmable	Channel Trigger, External, Software, Window, Pulse, Re-Arm, Spike, Or/And, Delay
Trigger level resolution	software programmable	14 bit
Trigger edge	software programmable	Rising edge, falling edge or both edges
Trigger pulse width	software programmable	0 to [64k - 1] samples in steps of 1 sample
Trigger delay	software programmable	0 to [64k - 1] samples in steps of 1 sample
Multi, Gate: re-arming time		< 4 samples (+ programmed pretrigger)
Pretrigger at Multi, ABA, Gate, FIFO	software programmable	4 up to [8176 Samples / number of active channels] in steps of 4
Posttrigger	software programmable	4 up to [8G - 4] samples in steps of 4 (defining pretrigger in standard scope mode)
Memory depth	software programmable	8 up to [installed memory / number of active channels] samples in steps of 4
Multiple Recording/ABA segment size	software programmable	8 up to [installed memory / 2 / active channels] samples in steps of 4
Trigger output delay		One positive edge after internal trigger event
Internal/External trigger accuracy		1 sample
External trigger type (input and output)		3.3V LVTTTL compatible (5V tolerant)
External trigger input		Low ≤ 0.8 V, High ≥ 2.0 V, ≥ 8 ns in pulse stretch mode, ≥ 2 clock periods all other modes
External trigger maximum voltage		-0.5 V up to +5.7 V (internally clamped to 5.0V, 100 mA max. clamping current)
Trigger impedance	software programmable	50 Ohm / high impedance (> 4 kOhm)
External trigger output type		3.3 V LVTTTL
External trigger output levels		Low ≤ 0.4 V, High ≥ 2.4 V, TTL compatible
External trigger output drive strength		Capable of driving 50 ohm load, maximum drive strength ± 128 mA

Clock

Clock Modes	software programmable	internal PLL, internal quartz, external clock, external divided, external reference clock, sync
Internal clock range (PLL mode)	software programmable	1 kS/s to max using internal reference, 50kS/s to max using external reference clock
Internal clock accuracy		≤ 20 ppm
Internal clock setup granularity		$\leq 1\%$ of range (100M, 10M, 1M, 100k,...): Examples: range 1M to 10M: stepsize ≤ 100 k
External reference clock range	software programmable	≥ 1.0 MHz and ≤ 125.0 MHz
External clock impedance	software programmable	50 Ohm / high impedance (> 4 kOhm)
External clock range		see „Dynamic Parameters“ table below
External clock delay to internal clock		5.4 ns
External clock type/edge		3.3V LVTTTL compatible, rising edge used
External clock input		Low level ≤ 0.8 V, High level ≥ 2.0 V, duty cycle: 45% - 55%
External clock maximum voltage		-0.5 V up to +3.8 V (internally clamped to 3.3V, 100 mA max. clamping current)
External clock output type		3.3 V LVTTTL
External clock output levels		Low ≤ 0.4 V, High ≥ 2.4 V, TTL compatible
External clock output drive strength		Capable of driving 50 ohm load, maximum drive strength ± 128 mA
Synchronization clock divider	software programmable	2 up to [8k - 2] in steps of 2
ABA mode clock divider for slow clock	software programmable	8 up to 524280 in steps of 8

BaseXIO Option

BaseXIO modes	software programmable	Asynch digital I/O, 2 additional trigger, timestamp reference clock, timestamp digital inputs
BaseXIO direction	software programmable	Each 4 lines can be programmed in direction
BaseXIO input		TTL compatible: Low ≤ 0.8 V, High ≥ 2.0 V
BaseXIO input impedance		4.7 kOhm towards 3.3 V
BaseXIO input maximum voltage		-0.5 V up to +5.5 V
BaseXIO output type		3.3 V LVTTTL
BaseXIO output levels		TTL compatible: Low ≤ 0.4 V, High ≥ 2.4 V
BaseXIO output drive strength		32 mA maximum current, no 50 Ω loads

Connectors

Analog Inputs (Single-Ended)		One MMCX female for each single-ended input	Cable-Type: Cab-1m-xx-xx
Analog Inputs (True Differential)		Two MMCX female for each differential input	Cable-Type: Cab-1m-xx-xx
Trigger Input/Output	programmable direction	3 mm SMB male (one connector)	Cable-Type: Cab-3f-xx-xx
Clock Input/Output	programmable direction	3 mm SMB male (one connector)	Cable-Type: Cab-3f-xx-xx
Option Digital Inputs/Outputs		40 pole half pitch (Hirose FX2 series)	Cable-Type: Cab-d40-xx-xx
Option BaseXIO		8 x 3 mm SMB male on extra bracket, internally 8 x MMCX female	

Environmental and Physical Details

Dimension (PCB only)	312 mm x 107 mm (full PCI length)
Width (Standard or with option star-hub 5)	1 full size slot
Width (star-hub 16)	additionally back of adjacent neighbour slots
Width (with option BaseXIO)	additionally extra bracket on neighbour slot
Width (with option -digin, -digout or -60xx-AmpMod)	additionally half length of adjacent neighbour slot
Weight (depending on version)	290g (smallest version) up to 460g (biggest version with all options, including star-hub)
Warm up time	10 minutes
Operating temperature	0°C to 50°C
Storage temperature	-10°C to 70°C
Humidity	10% to 90%

PCI/PCI-X specific details

PCI / PCI-X bus slot type	32 bit 33 MHz or 32 bit 66 MHz
PCI / PCI-X bus slot compatibility	32/64 bit, 33-133 MHz, 3,3 V and 5 V I/O
Sustained streaming mode	> 245 MB/s (in a PCI-X slot clocked at 66 MHz or higher)

PCI Express specific details

PCIe slot type	x1 Generation 1
PCIe slot compatibility	x1/x4/x8/x16 (Some x16 PCIe slots are for graphic cards only and can not be used)
Sustained streaming mode	> 160 MB/s

Certification, Compliance, Warranty

EMC Immunity	Compliant with CE Mark
EMC Emission	Compliant with CE Mark
Product warranty	5 years starting with the day of delivery
Software and firmware updates	Life-time, free of charge

Power Consumption

	PCI / PCI-X			PCI EXPRESS		
	3.3 V	5 V	Total	3.3V	12V	Total
M2i.46x0 (256 MSample memory)	1.9 A	0.6 A	9.3 W	0.4 A	0.9 A	12.2 W
M2i.46x1 (256 MSample memory)	1.9 A	1.0 A	11.3 W	0.4 A	1.1 A	14.6 W
M2i.46x2 (256 MSample memory)	2.0 A	1.9 A	16.1 W	0.4 A	1.5 A	19.4 W
M2i.46x2 (2 GSsample memory)	3.1 A	1.9 A	19.8 W	0.4 A	2.1 A	26.6 W

MTBF

MTBF	100000 hours
------	--------------

Dynamic Parameters

	M2i.4620	M2i.4621 M2i.4622 DN2.462	M2i.4630	M2i.4631 M2i.4632	M2i.4640	M2i.4641 M2i.4642 DN2.464	M2i.4650	M2i.4651 M2i.4652 DN2.465
max internal clock	200 kS/s		500 kS/s		1 MS/s		3 MS/s	
min external clock (special clock mode)	DC (DC)		DC (DC)		1 kS/s (DC)		1 kS/s (DC)	
max external clock (special clock mode)	200 kS/s (200 kS/S)		500 kS/s (500 kS/s)		1 MS/s (800 kS/s)		3 MS/s (2 MS/s)	
-3 dB bandwidth	>100 kHz		>250 kHz		>500 kHz		>1.5 MHz	
Zero noise level (Range $\geq \pm 500$ mV)	< 0.8 LSB rms		< 0.9 LSB rms		< 1.1 LSB rms		< 3.0 LSB rms	
Zero noise level (Range < ± 500 mV)	< 8 μ V rms		< 10 μ V rms		< 17 μ V rms		< 30 μ V rms	
Test - sampling rate	200 kS/s		500 kS/s		1 MS/s		3 MS/s	
Test signal frequency	10 kHz		10 kHz		10 kHz		10 kHz	
SNR (typ)	91.8 dB	91.5 dB	91.2 dB	91.0 dB	91.0 dB	90.7 dB	84.0 dB	82.5 dB
THD (typ)	-102.0 dB	-101.7 dB	-101.8 dB	-101.6 dB	-101.5 dB	-100.8 dB	-94.5 dB	-90.1 dB
SFDR (typ), excl. harm.	112.0 dB	111.5 dB	112.0 dB	111.5 dB	112.0 dB	111.2 dB	107.0 dB	105.5 dB
ENOB (based on SNR)	15.0 bit	14.9 bit	14.9 bit	14.8 bit	14.8 bit	14.7 bit	13.6 bit	13.4 bit
ENOB (based on SINAD)	14.9 bit	14.8 bit	14.8 bit	14.7 bit	14.7 bit	14.6 bit	13.5 bit	13.3 bit

Dynamic parameters are measured at ± 5 V input range (if no other range is stated) and 1 MOhm termination with the sampling rate specified in the table. Measured parameters are averaged 20 times to get typical values. Test signal is a pure sine wave of the specified frequency with > 99% amplitude. SNR and RMS noise parameters may differ depending on the quality of the used PC. SNR = Signal to Noise Ratio, THD = Total Harmonic Distortion, SFDR = Spurious Free Dynamic Range, SINAD = Signal Noise and Distortion, ENOB = Effective Number of Bits. For a detailed description please see application note 002.

Hardware block diagram

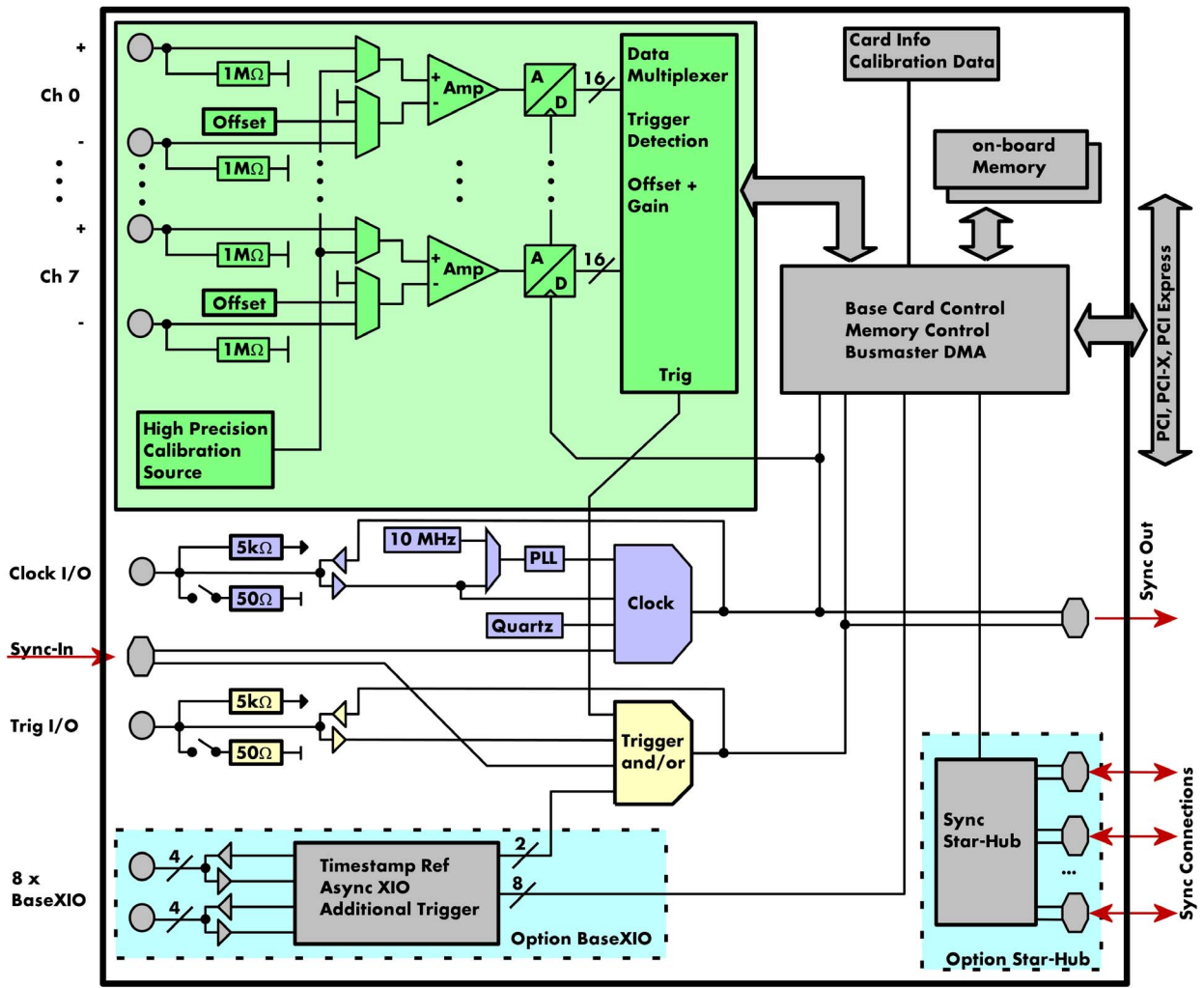

Order Information

The card is delivered with 256 MSample on-board memory and supports standard acquisition (Scope), FIFO acquisition (streaming), Multiple Recording, Gated Sampling, ABA mode and Timestamps. Operating system drivers for Windows/Linux 32 bit and 64 bit, examples for C/C++, LabVIEW (Windows), MATLAB (Windows and Linux), LabWindows/CVI, IVI, .NET, Delphi, Visual Basic, Java, Python and a Base license of the oscilloscope software SBench 6 are included. Drivers for other 3rd party products like VEE or DASyLab may be available on request.

Adapter cables are not included. Please order separately!

PCI Express (PCIe) PCI/PCI-X	PCI Express	PCI/PCI-X	Standard mem	1 channel	2 channels	4 channels	8 channels
	M2i.4620-exp	M2i.4620	256 MSample	200 kS/s	200 kS/s		
	M2i.4621-exp	M2i.4621	256 MSample	200 kS/s	200 kS/s	200 kS/s	
	M2i.4622-exp	M2i.4622	256 MSample	200 kS/s	200 kS/s	200 kS/s	200 kS/s
	M2i.4630-exp	M2i.4630	256 MSample	500 kS/s	500 kS/s		
	M2i.4631-exp	M2i.4631	256 MSample	500 kS/s	500 kS/s	500 kS/s	
	M2i.4632-exp	M2i.4632	256 MSample	500 kS/s	500 kS/s	500 kS/s	500 kS/s
	M2i.4640-exp	M2i.4640	256 MSample	1 MS/s	1 MS/s		
	M2i.4641-exp	M2i.4641	256 MSample	1 MS/s	1 MS/s	1 MS/s	
	M2i.4642-exp	M2i.4642	256 MSample	1 MS/s	1 MS/s	1 MS/s	1 MS/s
	M2i.4650-exp	M2i.4650	256 MSample	3 MS/s	3 MS/s		
	M2i.4651-exp	M2i.4651	256 MSample	3 MS/s	3 MS/s	3 MS/s	
	M2i.4652-exp	M2i.4652	256 MSample	3 MS/s	3 MS/s	3 MS/s	3 MS/s

Memory	Order no.	Option
	M2i.xxxx-512MS	Memory upgrade to 512 MSample (1 GB) total memory
	M2i.xxxx-1GS	Memory upgrade to 1 GSample (2 GB) total memory

Options	Order no.	Option
	M2i.xxxx-SH5 (1)	Synchronization Star-Hub for up to 5 cards, only 1 slot width
	M2i.xxxx-SH16 (1)	Synchronization Star-Hub for up to 16 cards
	M2i.xxxx-SSHM (1)	System-Star-Hub Master for up to 15 cards in the system and up to 17 systems, PCI 32 Bit card, sync cables and extra bracket for clock and trigger distribution included
	M2i.xxxx-SSHMe (1)	System-Star-Hub Master for up to 15 cards in the system and up to 17 systems, PCI Express card, sync cables and extra bracket for clock and trigger distribution included
	M2i.xxxx-SSHS5 (1)	System-Star-Hub Slave for 5 cards in one system, one slot width all sync cables + bracket included
	M2i.xxxx-SSHS16 (1)	System-Star-Hub Slave for 16 cards in system, two slots width, all sync cables + bracket included
	M2i.xxxx-bxio	Option BaseXIO: 8 digital I/O lines usable as asynchronous I/O, timestamp ref-clock and additional external trigger lines, additional bracket with 8 SMB connectors
	M2i-upgrade	Upgrade for M2i.xxxx: later installation of option -M2i.xxxx-1GS, -SH5, -SH16 or -bxio

Services	Order no.	
	Recal	Recalibration at Spectrum incl. calibration protocol

Cables		Order no.				
for Connections	Length	to BNC male	to BNC female	to SMA male	to SMA female	to SMB female
Analog Inputs	80 cm	Cab-1m-9m-80	Cab-1m-9f-80	Cab-1m-3mA-80	Cab-1m-3fA-80	Cab-1m-3f-80
Analog Inputs	200 cm	Cab-1m-9m-200	Cab-1m-9f-200	Cab-1m-3mA-200	Cab-1m-3fA-200	Cab-1m-3f-200
Probes (short)	5 cm		Cab-1m-9f-5			
Trigger/Clock I/O	80 cm	Cab-3f-9m-80	Cab-3f-9f-80	Cab-3f-3mA-80	Cab-3f-3fA-80	Cab-3f-3f-80
Trigger/Clock I/O	200 cm	Cab-3f-9m-200	Cab-3f-9f-200	Cab-3f-3mA-200	Cab-3f-3fA-200	Cab-3f-3f-200

Software SBench6	Order no.	
	SBench6	Base version included in delivery. Supports standard mode for one card.
	SBench6-Pro	Professional version for one card: FIFO mode, export/import, calculation functions
	SBench6-Multi	Option multiple cards: Needs SBench6-Pro. Handles multiple synchronized cards in one system.
	Volume Licenses	Please ask Spectrum for details.

Software Options	Order no.	
	Spc-RServer	Remote Server Software Package - LAN remote access for M2i/M3i/M4i/M4x/M2p cards

⁽¹⁾ : Just one of the options can be installed on a card at a time.

⁽²⁾ : Third party product with warranty differing from our export conditions. No volume rebate possible.

Technical changes and printing errors possible

SBench, digitizerNETBOX and generatorNETBOX are registered trademarks of Spectrum Instrumentation GmbH. Microsoft, Visual C++, Visual Basic, Windows, Windows 98, Windows NT, Window 2000, Windows XP, Windows Vista, Windows 7, Windows 8 and Windows 10 are trademarks/registered trademarks of Microsoft Corporation. LabVIEW, DASyLab, Diadem and LabWindows/CVI are trademarks/registered trademarks of National Instruments Corporation. MATLAB is a trademark/registered trademark of The Mathworks, Inc. Keysight VEE, VEE Pro and VEE OneLab are trademarks/registered trademarks of Keysight Technologies, Inc. FlexPro is a registered trademark of Weisang GmbH & Co. KG. PCIe, PCI Express and PCI-X and PCI-SIG are trademarks of PCI-SIG. LXI is a registered trademark of the LXI Consortium. PICMG and CompactPCI are trademarks of the PCI Industrial Computation Manufacturers Group. Oracle and Java are registered trademarks of Oracle and/or its affiliates. Intel and Intel Xeon are trademarks or registered trademarks of Intel Corporation. AMD and Optron are trademarks or registered trademarks of Advanced Micro Devices.