

M2i.60xx - 14 bit 125 MS/s Arbitrary Waveform Generator

- Fast 14 bit arbitrary waveform generator
- 1, 2 or 4 channels with 20 MS/s, 60 MS/s or 125 MS/s
- Simultaneous generation on all channels
- Output up to ± 3 V in 50 Ohm
- Amplifier option available for ± 10 V
- Offset and amplitude programmable
- 3 software selectable filters
- Up to 1 GSample on-board memory
- 256 MSample standard memory installed
- FIFO mode continuous streaming output
- Synchronization of up to 16 cards per system and up to 271 cards with system sync
- Features: Multiple Replay, Gated Replay, BaseXIO, Digital Outputs, Amplifier

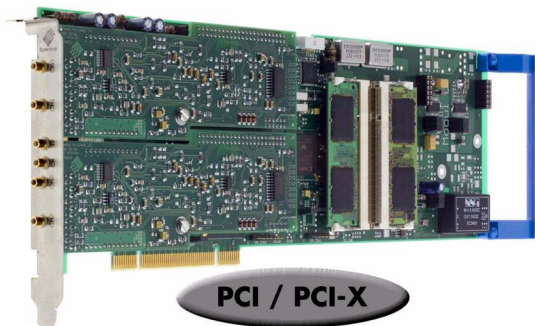

PCI / PCI-X

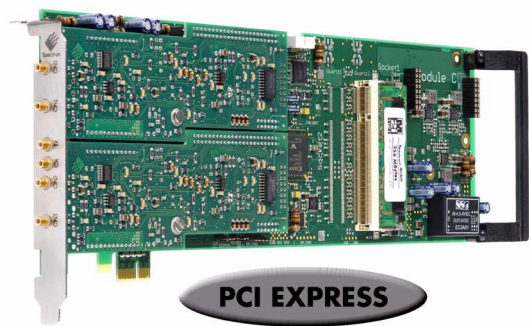

PCI EXPRESS

- 66 MHz 32 bit PCI-X interface
- 5V / 3.3V PCI compatible
- 100% compatible to conventional PCI > V2.1
- Sustained streaming mode up to 245 MB/s

- 2,5 GBit x1 PCIe Interface
- Works with x1/x4/x8/x16* PCIe slots
- Software compatible to PCI
- Sustained streaming mode up to 160 MB/s

Operating Systems

- Windows XP, Vista, 7, 8, 10
- Linux Kernel 2.4, 2.6, 3.x, 4.x
- Windows/Linux 32 and 64 bit

Recommended Software

- SBench 6
- MATLAB
- LabVIEW, LabWindows/CVI

Drivers and Examples

- Visual Basic, C/C++, GNU C++
- Borland Delphi, .VB.NET, C#, J#
- Python, Java

Model	1 channel	2 channels	4 channels
M2i.6011	20 MS/s	20 MS/s	
M2i.6012	20 MS/s	20 MS/s	20 MS/s
M2i.6021	60 MS/s	60 MS/s	
M2i.6022	60 MS/s	60 MS/s	60 MS/s
M2i.6030	125 MS/s		
M2i.6031	125 MS/s	125 MS/s	
M2i.6033	125 MS/s	62.5 MS/s	
M2i.6034	125 MS/s	125 MS/s	62.5 MS/s

General Information

The M2i.60xx series offers 8 different versions of arbitrary waveform generators for the PCI/PCI-X bus and PCI Express. With these boards it is possible to generate free definable waveforms on several channels synchronously. With one of the synchronization options the setup of synchronous multi channel systems is possible. It is also possible to combine the arbitrary waveform generator with other boards of the M2i product family like analog acquisition or digital I/O boards. With the up to 1 GSample large on-board memory long waveforms can be generated even with high sampling rates. All boards of the M2i.60xx series may use the whole installed on-board memory completely for the currently activated number of channels. The memory can also be used as a FIFO buffer to make continuously data transfer from PC memory or hard disk.

*Some x16 PCIe slots are for the use of graphic cards only and can not be used for other cards.

Software Support

Windows drivers

The cards are delivered with drivers for Windows XP, as well as Vista, Windows 7 and Windows 8 (each 32 bit and 64 bit). Programming examples for Visual C++, Borland C++ Builder, LabWindows/CVI, Borland Delphi, Visual Basic, VB.NET, C#, J#, Java and Python are included.

Linux Drivers



All cards are delivered with full Linux support. Pre compiled kernel modules are included for the most common distributions like RedHat, Fedora, Suse, Ubuntu LTS or Debian. The Linux support includes SMP systems, 32 bit and 64 bit systems, versatile programming examples for Gnu C++, Python as well as the possibility to get the driver sources for your own compilation.

SPEasyGenerator



For a fast start with the hardware the simple signal generation software SPEasyGenerator is included in the delivery. This software allows to generate simple signal shapes like sine, triangle or rectangle with programmable frequency, amplitude and phase. SPEasyGenerator is also available as LabWindows source code.

SBench

A full licence of SBench the easy-to-use graphical operating software for the Spectrum cards is included in the delivery. The version 6 is running under Windows as well as under Linux (KDE and GNOME).

Third-party products

Spectrum supports the most popular third-party software products such as LabVIEW, MATLAB or LabWindows/CVI. All drivers come with detailed documentation and working examples are included in the delivery. Support for other software packages, like VEE or DataSylab, can also be provided on request.

MI Software compatibility layer

To allow an easy change from MI cards to the new M2i cards for existing software a special software compatibility layer is delivered with the cards. This DLL converts MI calls to M2i calls and simulates a MI card in the software.

Hardware features and options

PCI/PCI-X



The cards with PCI/PCI-X bus connector use 32 Bit and up to 66 MHz clock rate for data transfer. They are 100% compatible to Conventional PCI > V2.1. The universal interface allows the use in PCI slots with 5 V I/O and 3.3 V I/O voltages as well as in PCI-

X or PCI 64 slots. The maximum sustained data transfer rate is 245 MByte/s per bus segment.

PCI Express



The cards with PCI Express use a x1 PCIe connector. They can be used in PCI Express x1/x4/x8/x16 slots, except special graphic card slots, and are 100% software compatible to

Conventional PCI > V2.1. The maximum sustained data transfer rate is 160 MByte/s per slot.

Singleshot output

When singleshot output is activated the data of the on-board memory is played exactly one time. The trigger source can be either one of the external trigger inputs or the software trigger. After the first trigger additional trigger events will be ignored.

Repeated output

When the repeated output mode is used the data of the on-board memory is played continuously for a programmed number of times or until a stop command is executed. The trigger source can be either one of the external trigger inputs or the software trigger. After the first trigger additional trigger events will be ignored.

Single Restart replay

When this mode is activated the data of the on-board memory will be replayed once after each trigger event. The trigger source can be either the external TTL trigger or software trigger.

FIFO mode

The FIFO mode is designed for continuous data transfer between PC memory or hard disk and the generation board. The control of the data stream is done automatically by the driver on an interrupt request basis. The complete installed on-board memory is used for buffering data, making the continuous streaming extremely reliable.

Multiple Replay

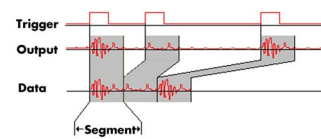

The Multiple Replay mode allows the fast output generation on several trigger events without restarting the hardware. With this option very fast repetition rates can be achieved. The on-board memory is divided into several segments of the same size. Each segment can contain different data which will then be played with the occurrence of each trigger event.

Gated Replay

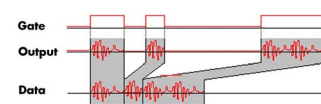

The Gated Sampling mode allows data replay controlled by an external gate signal. Data is only replayed if the gate signal has attained a

programmed level.

Sequence Mode

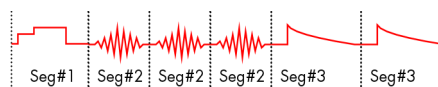

The sequence mode allows to split the card memory into several

data segments of different length. These data segments are chained up in a user chosen order using an additional sequence memory. In this sequence memory the number of loops for each segment can be programmed and trigger conditions can be defined to proceed from segment to segment. Using the sequence mode it is also possible to switch between replay waveforms by a simple software command or to redefine waveform data for segments simultaneously while other segments are being replayed.

Digital marker outputs on bracket

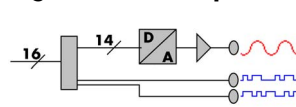

This option outputs additional synchronous digital channels phase-stable with the analog data. This option is available with 2 digital outputs (M2i.60xx-2DigM) and 4 digital outputs (M2i.60xx-4DigM). When this option is installed the additional digital outputs are directly connected to the front plate on

additional SMB connectors and don't occupy an extra slot. The digital data is stored in the upper two bits of the 16 bit data word.

Digital marker outputs

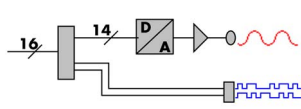

This option outputs additional synchronous digital channels phase-stable with the analog data. When this option is installed there are 2 additional digital out-

puts for every analog D/A channel. The digital data is stored in the upper two bits of the 16 bit data word.

External trigger I/O

All digital boards can be triggered using an additional external TTL signal per acquisition module. It's possible to use positive or negative edge also in combination with a programmable pulse width. An internally recognized trigger event can - when activated by software - be routed to the trigger output connector to start external instruments.

Pulse width

Defines the minimum or maximum width that a trigger pulse must have to generate a trigger event. Pulse width can be combined with channel trigger, pattern trigger and external trigger.

External clock I/O

Using a dedicated line a sampling clock can be fed in from an external system. It's also possible to output the internally used sampling clock to synchronize external equipment to this clock.

Reference clock

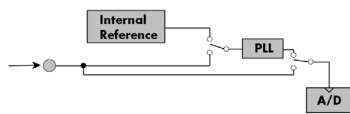

The option to use a precise external reference clock (typically 10 MHz) is necessary to synchronize the instrument for high-quality

measurements with external equipment (like a signal source). It's also possible to enhance the stability of the sampling clock in this way. The driver automatically generates the requested sampling clock from the fed in reference clock.

±10 V Amplifier



The amplifier board allows the output of ± 10 V on up to four channels without software modification. The standard outputs of the card are amplified by factor 3.33. The amplifier which has 30 MHz bandwidth has an output impedance of 50 Ohm. This allows ± 10 V with high impedance termination or ± 5 V with 50 ohm termination.

Star-Hub



The star-hub is an additional module allowing the phase stable synchronisation of up to 16 boards in one system. Independent of the number of boards there is no phase delay between all channels. The star-hub distributes trigger and

clock information between all boards. As a result all connected boards are running with the same clock and the same trigger. All trigger sources can be combined with OR/AND allowing all channels of all cards to be trigger source at the same time. The star-hub is available as 5 card and 16 card version. The 5 card version doesn't need an extra slot.

271 synchronous cards with the System Star-Hub

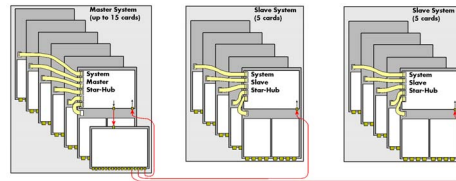

With the help of multiple system star-hubs it is possible to link up to 17 system phase synchronous with each other.

Each system can then contain up to 16 cards (master only 15). In total 271 cards can be used fully synchronously in a bunch of systems. One master system distributes clock and trigger signal to all connected slave systems.

BaseXIO (Asynchronous I/O, enhanced trigger)

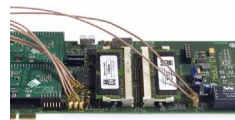

The BaseXIO option offers 8 asynchronous digital I/O lines on the base card. The direction can be selected by software in groups of four. This allows e.g. external equipment control or status monitoring.

Two of these lines can also be used as additional external trigger sources. This allows the building of complex trigger conjunctions with external gated triggers as well as AND/OR conjunction of multiple external trigger sources like, for example, the picture and row synchronisation of video signals. In addition one of the I/O lines can be used as reference clock for the Timestamp counter.

Technical Data

Analog Outputs

Resolution		14 bit
Output amplitude	software programmable	±100 mV up to ±3 V in 1 mV steps (Amp option: ±333 mV up to ±10 V in 3 mV steps)
Output offset	software programmable	±3 V in 1 mV steps (Amp option: ±10 V in 3 mV steps)
Filters	software programmable	no filter or one of 3 different filters as defined in technical data section
DAC Differential non linearity (DNL)	DAC only	±1.5 LSB typical
DAC Integral non linearity (INL)	DAC only	±1.0 LSB typical
Output resistance		< 1 Ohm
Minimum output load		35 Ohm (not short circuit protected)
Max output swing in 50 Ohm		± 3 V (offset + amplitude)
Max slew rate (no filter)		> 0.9 V/ns
Crosstalk @ 1 MHz signal ±3 V		< -80 dB
Output accuracy		< 1%

Trigger

Running mode	software programmable	Singleshot, FIFO mode (Streaming), Repeated Replay, Single Restart, Sequence Mode
Trigger edge	software programmable	Rising edge, falling edge or both edges
Trigger pulse width	software programmable	0 to [64k - 1] samples in steps of 1 sample
Trigger delay	software programmable	0 to [64k - 1] samples in steps of 1 sample
Memory depth	software programmable	8 up to [installed memory / number of active channels] samples in steps of 4
Multiple Replay segment size	software programmable	8 up to [installed memory / 2 / active channels] samples in steps of 4
Multiple Replay, Gated Replay: re-arming time		< 4 samples
Trigger output delay		One positive edge after internal trigger event
Internal/External trigger accuracy		1 sample
External trigger type (input and output)		3.3V LVTTTL compatible (5V tolerant)
External trigger input		Low ≤ 0.8 V, High ≥ 2.0 V, ≥ 8 ns in pulse stretch mode, ≥ 2 clock periods all other modes
External trigger maximum voltage		-0.5 V up to +5.7 V (internally clamped to 5.0V, 100 mA max. clamping current)
Trigger impedance	software programmable	50 Ohm / high impedance (> 4kOhm)
External trigger output type		3.3 V LVTTTL
External trigger output levels		Low ≤ 0.4 V, High ≥ 2.4 V, TTL compatible
External trigger output drive strength		Capable of driving 50 ohm load, maximum drive strength ±128 mA
Output delay trigger to 1st sample		15/16 clocks (2/1 channel/module)
Gate end to last replayed sample		15/16 clocks (2/1 channel/module)
Gate end alignment		2 samples (1 ch), 1 sample (2 or 4 ch)

Clock

Clock Modes	software programmable	internal PLL, internal quartz, external clock, external divided, external reference clock, sync
Internal clock range (PLL mode)	software programmable	1 kS/s to max using internal reference, 50kS/s to max using external reference clock
Internal clock accuracy		≤ 20 ppm
Internal clock setup granularity		≤ 1% of range (100M, 10M, 1M, 100k,...): Examples: range 1M to 10M: stepsize ≤ 100k
External reference clock range	software programmable	≥ 1.0 MHz and ≤ 125.0 MHz
External clock impedance	software programmable	50 Ohm / high impedance (> 4kOhm)
External clock range		see „Dynamic Parameters“ table below
External clock delay to internal clock		5.4 ns
External clock type/edge		3.3V LVTTTL compatible, rising edge used
External clock input		Low level ≤ 0.8 V, High level ≥ 2.0 V, duty cycle: 45% - 55%
External clock maximum voltage		-0.5 V up to +3.8 V (internally clamped to 3.3V, 100 mA max. clamping current)
External clock output type		3.3 V LVTTTL
External clock output levels		Low ≤ 0.4 V, High ≥ 2.4 V, TTL compatible
External clock output drive strength		Capable of driving 50 ohm load, maximum drive strength ±128 mA
Synchronization clock divider	software programmable	2 up to [8k - 2] in steps of 2
ABA mode clock divider for slow clock	software programmable	8 up to 524280 in steps of 8

Clock and Filter

	M2i.6011 M2i.6012	M2i.6021 M2i.6022	M2i.6030 M2i.6031 M2i.6033 M2i.6034 DN2.603-xx
max internal clock	20 MS/s	62.5 MS/s	125 MS/s
max external clock	20 MS/s	62.5 MS/s	125 MS/s
-3 dB bandwidth no filter	> 10 MHz	> 30 MHz	> 60 MHz
Filter 3: Characteristics	4th order Butterworth		5th order Butterworth
Filter 3: -3 dB bandwidth	5 MHz (typ. 5.4 MHz)	10 MHz (typ. 11.4 MHz)	25 MHz (typ. 26.5 MHz)
Filter 2: Characteristics	4th order Butterworth		4th order Butterworth
Filter 2: -3 dB bandwidth	1 MHz (typ. 1.2 MHz)	2 MHz (typ. 2.4 MHz)	5 MHz (typ. 5.8 MHz)
Filter 1: Characteristics	4th order Butterworth		4th order Butterworth
Filter 1: -3 dB bandwidth	100 kHz (typ. 96 kHz)	200 kHz (typ. 200 kHz)	500 kHz (typ. 495 kHz)

Sequence Replay Mode

Number of sequence steps	software programmable	1 up to 512 (sequence steps can be overloaded at runtime)
Number of memory segments	software programmable	2 up to 256 (segment data can be overloaded at runtime)
Loop Count	software programmable	1 to 1M loops
Sequence Step Commands	software programmable	Loop for #Loops, Next, Loop until Trigger, End Sequence
Special Commands	software programmable	Data Overload at runtime, sequence steps overload at runtime

Digital Outputs Options

Digital data generation modes	software programmable	2 digital channels per generated analog channels
Digital outputs delay to analog sample		no delay
Output voltage		Low ≤ 0.4 V, High ≥ 3.8 V
Output current		max. ± 8 mA

BaseXIO Option

BaseXIO modes	software programmable	Asynch digital I/O, 2 additional trigger, timestamp reference clock, timestamp digital inputs
BaseXIO direction	software programmable	Each 4 lines can be programmed in direction
BaseXIO input		TTL compatible: Low ≤ 0.8 V, High ≥ 2.0 V
BaseXIO input impedance		4.7 kOhm towards 3.3 V
BaseXIO input maximum voltage		-0.5 V up to +5.5 V
BaseXIO output type		3.3 V LV TTL
BaseXIO output levels		TTL compatible: Low ≤ 0.4 V, High ≥ 2.4 V
BaseXIO output drive strength		32 mA maximum current, no 50 Ω loads

Amplifier Module M2i.xxxx-AmpMod Option (Model M2i.6030 only)

Bandwidth	30 MHz
Output impedance	50 Ohm
Max. Output Voltage (into high impedance load)	± 10 V
Max. Output Voltage (into 50 Ohm load)	± 5 V
Gain Error	$\leq \pm 1$ %
Offset Error	$\leq \pm 50$ mV
Short-circuit-proof	Yes

± 10 V Amplifier Card Options

Bandwidth	30 MHz
Max. input voltage	± 3 V
Output impedance	50 Ω
Fixed Amplification	$\times 3.3$
Max. Output Voltage (into high impedance load)	± 10 V
Max. Output Voltage (into 50 Ohm load)	± 5 V
Analog ground to PC system ground impedance	10 k Ω (with ground jumper unplugged), 0 Ω (when ground jumper is plugged)
Gain Error	$\leq \pm 1$ %
Offset Error	$\leq \pm 50$ mV

PCIe Version M2i.6-Exp-1Amp/2Amp/4Amp

Interface	PCIe x1 (power connection only)
Dimension (PCB without SMB connectors)	147 mm x 106 mm
Power Consumption 3.3 V	0.0 A
Power Consumption 12.0 V	-1Amp and -2Amp: 1.1 A, -4Amp: 2.1 A

PCI Version MI.6xxxx-1Amp/2Amp/4Amp

Interface	PCI 32 Bit 33 MHz (power connection only)
Dimension (PCB without SMB connectors)	147 mm x 106 mm
Power Consumption 3.3 V	0.0 A
Power Consumption 5.0 V	-1Amp and -2Amp: 2.5 A, -4Amp: 5.0 A

Connectors

Analog Outputs		3 mm SMB male (one for each single-ended input)	Cable-Type: Cab-3f-xx-xx
Trigger Input/Output	programmable direction	3 mm SMB male (one connector)	Cable-Type: Cab-3f-xx-xx
Clock Input/Output	programmable direction	3 mm SMB male (one connector)	Cable-Type: Cab-3f-xx-xx
Option Digital Marker Outputs		40 pole half pitch (Hirose FX2 series)	Cable-Type: Cab-d40-xx-xx
Option Digital Marker Outputs on Bracket		3 mm SMB male (two or four connectors)	Cable-Type: Cab-3f-xx-xx
Option BaseXIO		8 x 3 mm SMB male on extra bracket, internally 8 x MMCX female	

Environmental and Physical Details

Dimension (PCB only)	312 mm x 107 mm (full PCI length)
Width (Standard or with option star-hub 5)	1 full size slot
Width (star-hub 16)	additionally back of adjacent neighbour slots
Width (with option BaseXIO)	additionally extra bracket on neighbour slot
Width (with option -digin, -digout or -60xx-AmpMod)	additionally half length of adjacent neighbour slot
Weight (depending on version)	290g (smallest version) up to 460g (biggest version with all options, including star-hub)
Warm up time	10 minutes
Operating temperature	0°C to 50°C
Storage temperature	-10°C to 70°C
Humidity	10% to 90%

PCI/PCI-X specific details

PCI / PCI-X bus slot type	32 bit 33 MHz or 32 bit 66 MHz
PCI / PCI-X bus slot compatibility	32/64 bit, 33-133 MHz, 3,3 V and 5 V I/O
Sustained streaming mode	> 245 MB/s (in a PCI-X slot clocked at 66 MHz or higher)

PCI Express specific details

PCIe slot type	x1 Generation 1
PCIe slot compatibility	x1/x4/x8/x16 (Some x16 PCIe slots are for graphic cards only and can not be used)
Sustained streaming mode	> 160 MB/s

Certification, Compliance, Warranty

EMC Immunity	Compliant with CE Mark
EMC Emission	Compliant with CE Mark
Product warranty	5 years starting with the day of delivery
Software and firmware updates	Life-time, free of charge

Power Consumption

	PCI / PCI-X			PCI EXPRESS		
	3.3 V	5 V	Total	3.3V	12V	Total
M2i.6030 (256 MS memory)	2.6 A	0.4 A	11.6 W	0.4 A	0.9 A	12.1 W
M2i.60x1/M2i.60x3 (256 MS mem.)	2.8 A	0.7 A	12.8 W	0.4 A	1.1 A	14.5 W
M2i.60x2/M2i.60x4 (256 MS mem.)	3.2 A	1.1 A	16.1 W	0.4 A	1.2 A	15.7 W
M2i.6034 (2 GS memory), max. power	4.9 A	1.1 A	21.7 W	0.4 A	1.7 A	21.7 W
M2i.6030 + Amplifier Module	2.6 A	2.9 A	23.1 W	TBD	TBD	TBD

MTBF

MTBF	400000 hours
------	--------------

Dynamic Parameters

	M2i.6011 M2i.6012	M2i.6011 M2i.6012	M2i.6011 M2i.6012	M2i.6021 M2i.6022	M2i.6021 M2i.6022	M2i.6030 M2i.6031 M2i.6033 M2i.6034 DN2.603-xx	M2i.6030 M2i.6031 M2i.6033 M2i.6034 DN2.603-xx	M2i.6030 M2i.6031 M2i.6033 M2i.6034 DN2.603-xx	M2i.6030 M2i.6031 M2i.6033 M2i.6034 DN2.603-xx
max internal / external clock	20 MS/s	20 MS/s	20 MS/s	60 MS/s	60 MS/s	62.5 MS/s	62.5 MS/s	125 MS/s	125 MS/s
min internal clock	1 kS/s	1 kS/s	1 kS/s	1 kS/s	1 kS/s	1 kS/s	1 kS/s	1 kS/s	1 kS/s
min external clock	DC	DC	DC	DC	DC	DC	DC	DC	DC
Test - Samplerate	20 MS/s	20 MS/s	20 MS/s	60 MS/s	60 MS/s	62.5 MS/s	62.5 MS/s	125 MS/s	125 MS/s
Output Frequency	80 kHz	800 kHz	4 MHz	170 kHz	1.7 MHz	400 kHz	4 MHz	400 kHz	4 MHz
Output Level	±2 V	±2 V	±2 V	±2 V	±2 V	±2 V	±2 V	±2 V	±2 V
Used Filter	100 kHz	1 MHz	5 MHz	200 kHz	2 MHz	500 kHz	5 MHz	500 kHz	5 MHz
SNR (typ)	> 61.5 dB	> 60.2 dB	> 54.5 dB	> 61.5 dB	> 59.5 dB	> 61.5 dB	> 55.0 dB	> 61.0 dB	> 56.0 dB
THD (typ)	< -70.4 dB	< -67.5 dB	< -45.0 dB	< -72.7 dB	< -62.5 dB	< -71.5 dB	< -55.6 dB	< -71.5 dB	< -56.0 dB
SFDR (typ), excl harm.	> 85.5 dB	> 72.0 dB	> 60.0 dB	> 81.5 dB	> 68.5 dB	> 82.8 dB	> 66.5 dB	> 72.0 dB	> 67.0 dB

Dynamic parameters are measured at ± 1 V input range (if no other range is stated) and 50 Ohm termination with the samplerate specified in the table. Measured parameters are averaged 20 times to get typical values. Test signal is a pure sine wave of the specified frequency with > 99% amplitude. SNR and RMS noise parameters may differ depending on the quality of the used PC. SNR = Signal to Noise Ratio, THD = Total Harmonic Distortion, SFDR = Spurious Free Dynamic Range, SINAD = Signal Noise and Distortion, ENOB = Effective Number of Bits. For a detailed description please see application note 002.

Hardware block diagram

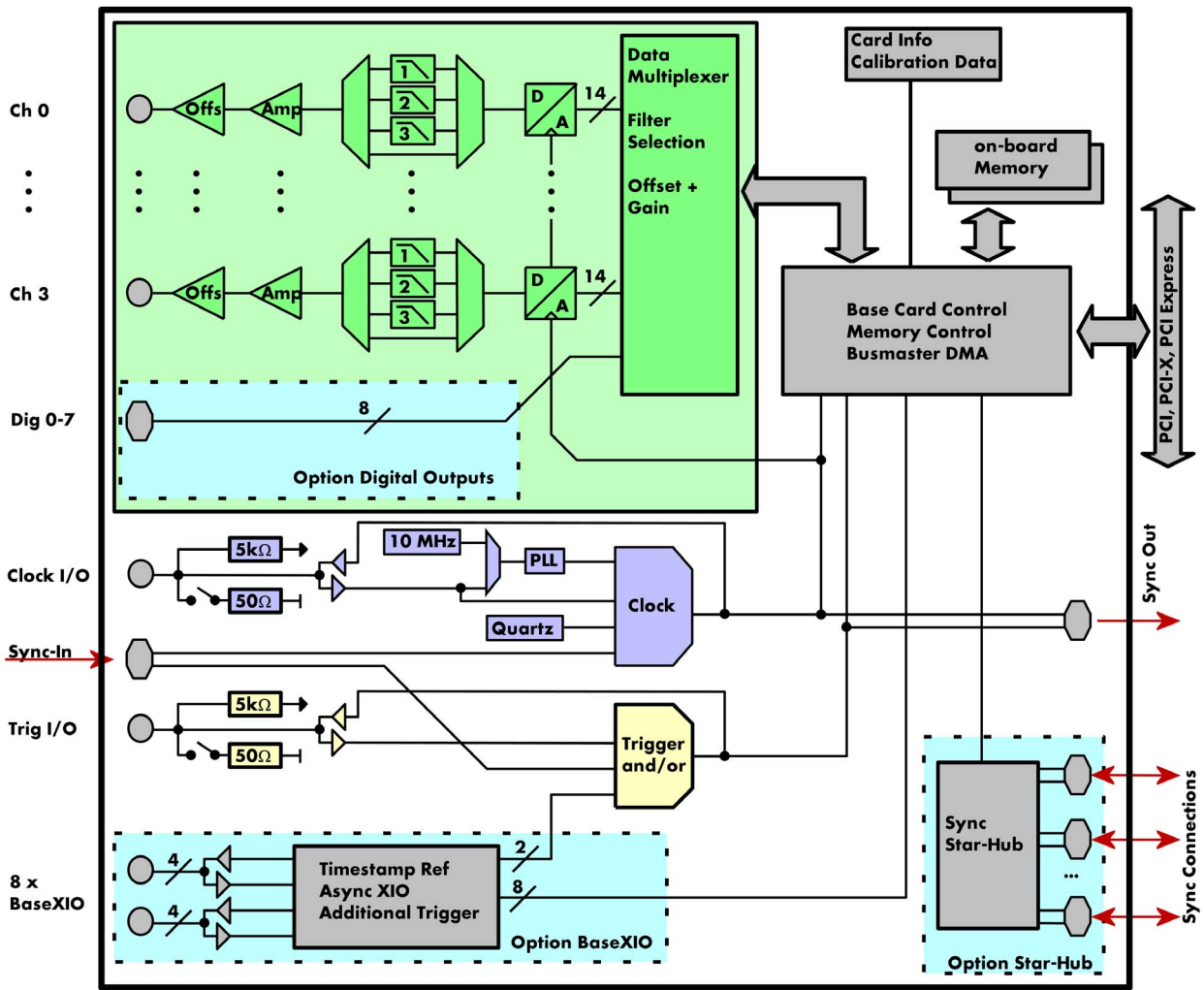

Order Information

The card is delivered with 256 MSample on-board memory and supports standard replay (single-shot, loop, single restart), FIFO replay (streaming), Multiple Replay, Gated Replay and Sequence Mode. Operating system drivers for Windows/Linux 32 bit and 64 bit, examples for C/C++, LabVIEW (Windows), MATLAB (Windows and Linux), LabWindows/CVI, .NET, Delphi, Visual Basic, Java, Python and a Base license of the oscilloscope software SBench 6 are included. Drivers for other 3rd party products like VEE or DASYLab may be available on request.

Adapter cables are not included. Please order separately!

PCI Express (PCIe) PCI/PCI-X	PCI Express	PCI/PCI-X	Standard mem	1 channel	2 channels	4 channels
	M2i.6011-exp	M2i.6011	256 MSample	20 MS/s	20 MS/s	
	M2i.6012-exp	M2i.6012	256 MSample	20 MS/s	20 MS/s	20 MS/s
	M2i.6021-exp	M2i.6021	256 MSample	60 MS/s	60 MS/s	
	M2i.6022-exp	M2i.6022	256 MSample	60 MS/s	60 MS/s	60 MS/s
	M2i.6030-exp	M2i.6030	256 MSample	125 MS/s		
	M2i.6031-exp	M2i.6031	256 MSample	125 MS/s	125 MS/s	
	M2i.6033-exp	M2i.6033	256 MSample	125 MS/s	60 MS/s	
	M2i.6034-exp	M2i.6034	256 MSample	125 MS/s	125 MS/s	60 MS/s

Memory	Order no.	Option
	M2i.xxxx-512MS	Memory upgrade to 512 MSample (1 GB) total memory
	M2i.xxxx-1GS	Memory upgrade to 1 GSample (2 GB) total memory

Options	Order no.	Option
	M2i.60xx-dig	Additional synchronous digital outputs (2 per analog channel) on extra bracket including flat ribbon cable 1m to IDC connector: Cab-d40-idc-100
	M2i.60xx-2DigM	2 additional synchronous digital outputs on SMB connectors on card's bracket. Suitable for cards with 1 analog module only (M2i.6011, M2i.6021, M2i.6030, M2i.6033)
	M2i.60xx-4DigM	4 additional synchronous digital outputs on SMB connectors on card's bracket. Suitable for cards with 2 analog modules only. (M2i.6012, M2i.6022, M2i.6031, M2i.6034)
	M2i.xxxx-SH5 (1)	Synchronization Star-Hub for up to 5 cards, only 1 slot width
	M2i.xxxx-SH16 (1)	Synchronization Star-Hub for up to 16 cards
	M2i.xxxx-SSHM (1)	System-Star-Hub Master for up to 15 cards in the system and up to 17 systems, PCI 32 Bit card, sync cables and extra bracket for clock and trigger distribution included
	M2i.xxxx-SSHMe (1)	System-Star-Hub Master for up to 15 cards in the system and up to 17 systems, PCI Express card, sync cables and extra bracket for clock and trigger distribution included
	M2i.xxxx-SSHS5 (1)	System-Star-Hub Slave for 5 cards in one system, one slot width all sync cables + bracket included
	M2i.xxxx-SSHS16 (1)	System-Star-Hub Slave for 16 cards in system, two slots width, all sync cables + bracket included
	M2i.60xx-AmpMod	M2i.6030 and M2i.6030-exp only: ±10 V output amplifier module mounted on card
	Mi.6xxx-1Amp	1 channel ±10 V output amplifier PCI 32 bit card including 15 cm SMB to SMB connection cable
	Mi.6xxx-2Amp	2 channel ±10 V output amplifier PCI 32 bit card including 15 cm SMB to SMB connection cables
	Mi.6xxx-4Amp	4 channel ±10 V output amplifier PCI 32 bit card including 15 cm SMB to SMB connection cables
	M2i.6-exp-1Amp	1 channel ±10 V output amplifier PCIe x1 card including 15 cm SMB to SMB connection cable
	M2i.6-exp-2Amp	2 channel ±10 V output amplifier PCIe x1 card including 15 cm SMB to SMB connection cables
	M2i.6-exp-4Amp	4 channel ±10 V output amplifier PCIe x1 card including 15 cm SMB to SMB connection cables
	M2i.xxxx-bxio	Option BaseXIO: 8 digital I/O lines usable as asynchronous I/O and additional external trigger lines, additional bracket with 8 SMB connectors
	M2i-upgrade	Upgrade for M2i.xxxx: later installation of option -M2i.xxxx-1GS, -dig, -2DigM, -4DigM, -SH5, -SH16 or -bxio

Services	Order no.	
	Recal	Recalibration at Spectrum incl. calibration protocol

Cables	for Connections	Length	Order no.	to BNC male	to BNC female	to SMA male	to SMA female	to SMB female
	Analog/Clock/Trigger	80 cm	Cab-3f-9m-80	Cab-3f-9f-80	Cab-3f-3mA-80	Cab-3f-3fA-80	Cab-3f-3f80	
	Analog/Clock/Trigger	200 cm	Cab-3f-9m-200	Cab-3f-9f-200	Cab-3f-3mA-200	Cab-3f-3fA-200	Cab-3f-3f200	
	Probes (short)	5 cm		Cab-3f-9f-5				
	Digital signals (option)	100 cm		to 2x20 pole IDC Cab-d40-idc-100	to 40 pole FX2 Cab-d40-d40-100			

Software SBench6	Order no.	
	SBench6	Base version included in delivery. Supports standard mode for one card.
	SBench6-Pro	Professional version for one card: FIFO mode, export/import, calculation functions
	SBench6-Multi	Option multiple cards: Needs SBench6-Pro. Handles multiple synchronized cards in one system.
	Volume Licenses	Please ask Spectrum for details.

Software Options	Order no.	
	SpC-RServer	Remote Server Software Package - LAN remote access for M2i/M3i/M4i/M4x/M2p cards

⁽¹⁾ : Just one of the options can be installed on a card at a time.

⁽²⁾ : Third party product with warranty differing from our export conditions. No volume rebate possible.

Technical changes and printing errors possible

SBench, digitizerNETBOX and generatorNETBOX are registered trademarks of Spectrum Instrumentation GmbH. Microsoft, Visual C++, Visual Basic, Windows, Windows 98, Windows NT, Window 2000, Windows XP, Windows Vista, Windows 7, Windows 8 and Windows 10 are trademarks/registered trademarks of Microsoft Corporation. LabVIEW, DASYLab, Diadem and LabWindows/CVI are trademarks/registered trademarks of National Instruments Corporation. MATLAB is a trademark/registered trademark of The Mathworks, Inc. Keysight VEE, VEE Pro and VEE OneLab are trademarks/registered trademarks of Keysight Technologies, Inc. FlexPro is a registered trademark of Weisang GmbH & Co. KG. PCIe, PCI Express and PCI-X are trademarks of PCI-SIG. LXI is a registered trademark of the LXI Consortium. PICMG and CompactPCI are trademarks of the PCI Industrial Computer Manufacturers Group. Oracle and Java are registered trademarks of Oracle and/or its affiliates. Intel and Intel Xeon are trademarks or registered trademarks of Intel Corporation. AMD and Opteron are trademarks or registered trademarks of Advanced Micro Devices.

